

University of Mississippi

eGrove

Electronic Theses and Dissertations

Graduate School

2014

Ramsey Theory Using Matroid Minors

Dixie Smith Horne

University of Mississippi

Follow this and additional works at: <https://egrove.olemiss.edu/etd>



Part of the [Mathematics Commons](#)

Recommended Citation

Horne, Dixie Smith, "Ramsey Theory Using Matroid Minors" (2014). *Electronic Theses and Dissertations*. 668.

<https://egrove.olemiss.edu/etd/668>

This Thesis is brought to you for free and open access by the Graduate School at eGrove. It has been accepted for inclusion in Electronic Theses and Dissertations by an authorized administrator of eGrove. For more information, please contact egrove@olemiss.edu.

Ramsey Theory Using Matroid Minors

A Thesis Presented for the

Master of Arts Degree

Department of Mathematics

The University of Mississippi

DIXIE SMITH HORNE

May 2014

Copyright Dixie Smith Horne 2014

ALL RIGHTS RESERVED

Abstract

This thesis considers a Ramsey Theory question for graphs and regular matroids. Specifically, how many elements N are required in a 3-connected graphic or regular matroid to force the existence of certain specified minors in that matroid? This question cannot be answered for an arbitrary collection of specified minors. However, there are results from the literature for which the number N exists for certain collections of minors. We first encode totally unimodular matrix representations of certain matroids. We use the computer program MACEK [9] to investigate this question for certain classes of specified minors.

Acknowledgments

I would like to express my deepest appreciation to my committee chair, Dr. Talmage James Reid, for his ideas and vast body of knowledge, and for his patience in helping me complete this thesis. It has been an honor to work with him. I would also like to thank Dr. Haidong Wu and Dr. Stanislaw Dziobiak for their support and willingness to serve on my committee. I am especially grateful to Dr. Kayla Davis Harville for teaching me how to use MACEK, for adding to my understanding of matroids, and for always being available for support and encouragement.

I would like to acknowledge the Mississippi Center for Supercomputing Research, with special thanks to Ben Pharr for his help in setting up the environment I needed to do this research and for being an invaluable resource. I would also like to thank my professors at the University of Mississippi, North Carolina State University and the University of North Carolina at Chapel Hill for giving me a background in mathematics and the humanities that has allowed me to get to this level.

Finally, I would like to thank my amazing son, Joseph. He is the brightest light in my world and I am deeply grateful for his faith in me.

Contents

Abstract	ii
Acknowledgments	iii
List of Figures	v
Chapter 1. Introduction	1
Chapter 2. Some New Ramsey Numbers	13
Chapter 3. Thesis Results	17
Bibliography	29
List of Appendices	33
Appendix A: Results From Graphic Extensions of \mathbf{W}_4	34
Appendix B: Results From Graphic Extensions of \mathbf{W}_5	37
Appendix C: Results From Graphic Extensions of \mathbf{W}_6	41
Appendix D: Results From Regular Extensions of \mathbf{W}_4	44
Appendix E: Results From Regular Extensions of \mathbf{W}_5	47
Appendix F: Results From Regular Extensions of \mathbf{W}_6	51
Appendix G: MACEK Commands and Examples	54
Vita	59

List of Figures

1.1	Graph Connectivity in the graph H	7
1.2	The Cube Graph	10
1.3	Matrix Representation for Cube	10
1.4	The Octahedron Graph	10
1.5	Matrix Representation for Octahedron	11
1.6	The Pyramid Graph	11
1.7	Matrix Representation for Pyramid	11
1.8	The Graph K_5^\perp	12
1.9	Matrix Representation for K_5^\perp	12
2.1	The Graph V_k	13
2.2	The Graph V_4	14
2.3	The Graph W_5	15
2.4	Matrix Representation for S_k	15
2.5	The Graphs $K'_{3,4}$, $K''_{3,4}$, and $K'''_{3,4}$	16

3.1	The 3-connected graphic Matroids with an $M(W_4)$ -minor but neither $M(W_5)$ nor $M(K_{3,n})$ as minors	20
3.2	The 3-connected graphic Matroids with an $M(W_5)$ -minor but neither $M(W_6)$ nor $M(K_{3,n})$ as a minor.	22
3.3	The 3-connected graphic Matroids with an $M(W_6)$ -minor but neither $M(W_7)$ nor $M(K_{3,n})$ as a minor	24
3.4	The 3-connected regular Matroids with an $M(W_4)$ -minor but no $M(K_{3,k})$, $M(K_{3,k})^*$, and $M(W_5)$ minors	25
3.5	The 3-connected regular Matroids with an $M(W_5)$ -minor but no $M(K_{3,k})$, $M(K_{3,k})^*$, and $M(W_6)$ minors	27
3.6	The 3-connected regular Matroids with an $M(W_6)$ -minor but no $M(K_{3,k})$, $M(K_{3,k})^*$, and $M(W_6)$ minors	28

CHAPTER 1

Introduction

This thesis is organized into three chapters. The first chapter outlines the classical results on Ramsey Theory that motivate this research as well as providing some basic concepts of Graph and Matroid Theory. The second chapter defines some new Ramsey numbers for graphs and matroids and gives results from the literature that establish that these numbers are well-defined. The third chapter of the thesis computes some exact values and lower bounds of these numbers.

Ramsey Theory is an area of mathematics in which a typical result is of the form that a sufficiently large mathematical system contains a highly ordered subsystem of a certain cardinality. This theory is named after Frank Plumpton Ramsey who first established that the numbers exist. Let k and ℓ be positive integers. The Ramsey number $r(k, \ell)$ is the least positive integer r such that every graph with r vertices contains either k mutually

m	n	$R(m, n)$	Reference
3	3	6	[7]
3	4	9	[7]
3	5	14	[7]
3	6	18	[6]
3	7	23	[10]
3	8	28	[12]
3	9	36	[8]
4	4	18	[7]
4	5	25	[13]

TABLE 1. Some Small Known Ramsey Numbers

adjacent vertices or ℓ mutually non-adjacent vertices. This number is among the most studied parameters in graph theory. Erdős and Szekeres [5] gave the following fundamental result on these numbers that establishes their existence.

THEOREM 1. *Let k and ℓ be positive integers exceeding one. Then:*

- (1) $r(k, \ell) \leq r(k-1, \ell) + r(k, \ell-1)$;
- (2) $r(k, \ell) < r(k-1, \ell) + r(k, \ell-1)$ if $r(k-1, \ell)$ and $r(k, \ell-1)$ are even;
- (3) $r(k, \ell) \leq \binom{k+\ell-2}{k-1}$.

Known exact values for Ramsey numbers are rare. Some of the values are summarized in Table 1. At the 1991 Seattle Conference on Graph Minors, Robin Thomas asked whether a connected matroid with bounded cardinality for both its circuits and cocircuits has a bounded number of elements. Lovász, Schrijver and Seymour provided an argument to show that such a matroid does have a bounded number of elements. Motivated by this observation, Reid [17] defined a matroid Ramsey number as follows and showed that these numbers satisfy conditions similar to the ones given in Theorem 1.

DEFINITION 1. *Let k and ℓ be positive integers. Then $n(k, \ell)$ is the least positive integer n such that every connected matroid M with n elements contains either a circuit with at least k elements or a cocircuit with at least ℓ elements.*

Pou-lin Wu [23] computed these numbers precisely for connected graphic matroids. Lemos and Oxley [11] computed these numbers precisely for all connected matroids. The result of Lemos and Oxley is given below.

THEOREM 2. *Let M be a connected matroid with at least two elements. If a largest circuit of M has k elements and a largest cocircuit of M has ℓ elements, then $|E(M)| \leq \lfloor \frac{k\ell}{2} \rfloor + 1$.*

Before exploring other Ramsey numbers associated with graphs and matroids, we conclude this section of the thesis with some basic concepts and classes of matroids and some fundamental results associated with them.

First we will give some graph and matroid terminology that will be used throughout the thesis. The graph terminology generally follows West [22], while the matroid terminology follows Oxley [15] for the most part. Let G be a graph throughout this chapter. A graph H is a *minor* of G if an isomorphic copy of H can be obtained from G by deleting and/or contracting edges and deleting isolated vertices from G [22]. Many properties of graphs are closed under minors; i.e., if G has property P , then a minor H of G also has property P . Equivalently, the contrapositive of this statement is that if H does not have property P , then G does not have property P . Many important classes of graphs are determined by their *excluded minors*; i.e., the minors that graphs in the class do not have. One of the first results of this type is Kuratowski's characterization of planar graphs. Note that the complete graph on k vertices is denoted by K_k while the complete bipartite graph with partite classes of cardinality k and ℓ is denoted by $K_{k,\ell}$.

THEOREM 3. *A finite graph is planar if and only if it contains no subgraph that is isomorphic to or is a subdivision of K_5 or $K_{3,3}$.*

Wagner [21] gave the following excluded-minor version of Kuratowski's result. The Ramsey results presented in Section 1 of this thesis can be considered as a variation of this classical excluded minor result.

THEOREM 4. *A graph is planar if and only if it contains no minor isomorphic to K_5 or $K_{3,3}$.*

The formal definition of a matroid as a set system is given below.

DEFINITION 2. *A matroid M is an ordered pair (E, \mathcal{I}) consisting of a finite set E and a collection \mathcal{I} of subsets of E satisfying the following three conditions:*

- (I1) $\emptyset \in \mathcal{I}$.
- (I2) If $I \in \mathcal{I}$ and $I' \subseteq I$, then $I' \in \mathcal{I}$.
- (I3) If $I_1, I_2 \in \mathcal{I}$ and $|I_1| < |I_2|$, then there is an element e of $I_2 - I_1$ such that $I_1 \cup e \in \mathcal{I}$.

Let $M = (E, \mathcal{I})$ be a matroid. The members of \mathcal{I} are called the independent subsets of M . The subsets of E that are not in \mathcal{I} are called the dependent subsets of M . The minimal dependent sets are said to be circuits of M . Let $X \subset E$. The rank of X , denoted by $r(X)$, is the cardinality of any maximal independent subset of X . These sets all have the same cardinality. A basis for M is a maximal independent subset of E . These sets again all have the same cardinality. The rank of M is the rank of E . There is a dual matroid, denoted by M^* , associated with M on the set E defined by letting the bases of M^* be precisely the complements of bases of M .

We next describe three important classes of matroids: the graphic matroids, matroids representable over a given field, and the regular matroids. The cycle matroid of the graph G , denoted by $M(G)$, has element set $E(G)$. A circuit of this matroid is precisely the edge set of a cycle of G . A matroid that is isomorphic to the cycle matroid of some graph is said to be graphic. Graphic matroids can also be defined by their excluded minors, as shown in the following theorem attributed to Tutte.

THEOREM 5. *A matroid is graphic if and only if it has no minor isomorphic to any of the matroids $U_{2,4}$, F_7 , F_7^* , $M^*(K_5)$, and $M^*(K_{3,3})$. [20]*

Let E be the set of column labels of a $k \times \ell$ matrix A over a field \mathbb{F} . Let \mathcal{I} be the set of subsets X of E for which the multiset of columns labelled by X is linearly independent in the vector space $V(k, \mathbb{F})$. Then \mathcal{I} is the set of independent sets of a matroid on E called the vector matroid of A . This matroid is denoted by $M[A]$. If M is isomorphic to the vector matroid of a matrix D over a field \mathbb{F} , then M is said to be *representable over \mathbb{F}* or \mathbb{F} -representable and D is called a *representation for M over \mathbb{F}* or an \mathbb{F} -*representation for M* [15]. One such class of representable matroids is the class of *regular matroids*. Such a matroid is the vector matroid of a totally unimodular matrix. A *unimodular matrix* is a matrix over \mathbb{R} for which every square submatrix has determinant in $\{0, 1, -1\}$. Some authors refer to a regular matroid as a *totally unimodular matroid* [20]. These characterizations of regular and graphic matroids will be fundamental to our work.

THEOREM 6. *A matroid is regular if and only if it has no minor isomorphic to $U_{2,4}$, F_7 or F_7^* . [24]*

One tool that is important in the study of matroid representability is the concept of connectivity. We motivate this concept first for the class of graphs. A *vertex cut* of a graph G is a set $S \subseteq V(G)$ such that $G - S$ has more connected components than G . The *connectivity* of G , written $\kappa(G)$, is defined as follows. If G is disconnected, then $\kappa(G) = 0$. If G is connected and contains a pair of non-adjacent vertices, then $\kappa(G)$ is the smallest integer j such that G has a j -element vertex cut. If G is connected and contains no pair of non-adjacent vertices, then $\kappa(G) = |V(G)| - 1$. For $k \in \mathbb{Z}^+$, a graph G is *k-connected* if its connectivity is at least k .

In order to illustrate graph connectivity consider the graph H given in Figure 1.1. This graph is connected so that $\kappa(H) \geq 1$. This graph contains many vertex-cuts. For example, the sets $\{c, d\}$ and $\{d, f\}$ are 2-vertex cuts, that is each is a vertex cut of cardinality two. The graph H does have pairs of non-adjacent vertices so $\kappa(H)$ is the smallest integer j such that H has a j -element vertex cut. It follows from H having no vertex cut of cardinality one that $\kappa(H) \geq 2$. The graph H has a 2-vertex cut $\{c, d\}$. Hence $\kappa(H) \leq 2$. So $\kappa(H) = 2$. Then $\kappa(H) \geq 2$ so we may say that H is a 2-connected graph. However, $\kappa(H) \not\geq 3$ so H is not a 3-connected graph.

The concept of k -connectedness for a matroid is less straightforward than that for a graph. The reason for this difference is that a matroid lacks the concept of a vertex. First we will describe motivation for the definition. Let M be the cycle matroid of the graph H

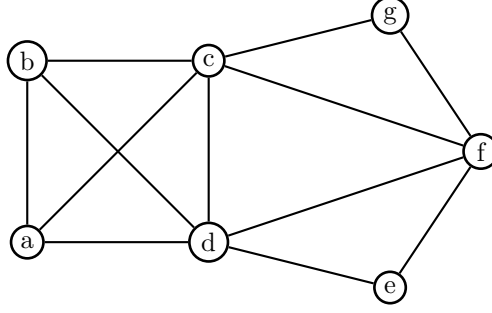

FIGURE 1.1. Graph Connectivity in the Graph H

given in Figure 1.1. Suppose X is the set of edges of the subgraph of H induced by the vertex set $\{a, b, c, d\}$ and Y is the set of edges of the subgraph of H induced by the vertex set $\{c, d, e, f, g\}$, except for the edge cd . Then (X, Y) is a partition of the element set of M . Now for any edge set Z of the graph H ,

$$r_{M(H)}(Z) = |V(H[Z])| - \omega(H[Z])$$

where $H[Z]$ is the subgraph of H induced by Z and $\omega(H[Z])$ is the number of connected components of $H[Z]$. Then

$$\begin{aligned} & r_{M(H)}(X) + r_{M(H)}(Y) - r(M(H)) \\ &= |V(H[X])| - \omega(H[X]) + |V(H[Y])| - \omega(H[Y]) - [|V(H)| - \omega(H)] \\ &= |V(H[X]) \cap V(H[Y])| - 1 = 2 - 1 = 1 \end{aligned}$$

Hence the 2-vertex cut $\{c, d\}$ of H is modeled by the edge partition (X, Y) as

$$r_{M(H)}(X) + r_{M(H)}(Y) - r(M(H)) = 1$$

Let M be a matroid with ground set E and $X \subseteq E$. Then

$$\lambda_M(X) = r(X) + r(E - X) - r(M)$$

We say that λ_M is the *connectivity function* of M , often abbreviated as λ . If $\lambda_M(X) < k$ for $k \in \mathbb{Z}^+$, then both X and $E-X$ are called k -separating sets. Note that $\lambda_M(X) = \lambda_M(E-X)$. A k -separation of M is a pair $(X, E-X)$ such that both X and $E-X$ are k -separating sets and each set has at least k elements. For an integer n exceeding one, the matroid M is n -connected if M has no k -separations for any $k \in \{1, 2, \dots, n-1\}$.

The cycle matroid of the graph G is representable over any field \mathbb{F} . In order to see this fact we next state the procedure for finding such a representation given in [16, p. 141]. We begin with a spanning tree of the graph G , say with r edges. Each edge of the spanning tree is assigned to precisely one of the r columns of the $r \times r$ identity matrix. We then define an arbitrary orientation $D(G)$ of G , and then assign a column of length r to each edge not in the spanning tree as follows. Let e be such an edge. There is a unique cycle using the edge e and edges of the spanning tree. Follow the direction of edge e along this cycle. The column representing e contains only 0's, 1's, and -1 's. Each entry in this column corresponds to the corresponding edge of the spanning tree. If the corresponding edge is not in the cycle, then 0 is recorded in the entry. If the corresponding edge is in the cycle in the same direction as e , then 1 is recorded in the entry. If the corresponding edge is in the cycle in the opposite direction as e , then -1 is recorded in the entry. The resulting matrix represents the matroid over any field \mathbb{F} . Often, the identity part of the matrix is omitted. For example, several such

\mathbb{F} -representations for given graphs used in this research are given in Figures 1.3, 1.5, 1.7, and 1.9. These regular representations were created using the UNIX text editor “vi” so that the resulting matroids could be utilized by the program MACEK. In each graph the edges of a spanning tree are shown as dashed lines, while the basis is represented by a solid line.

In order to study properties of representable matroids, sophisticated connectivity tools are necessary. We next mention two such results from the literature that are needed in this research. The first such result is Seymour’s Splitter Theorem [18].

THEOREM 7. *Let M and N be 3-connected matroids such that N is a minor of M with at least four elements and if N is a wheel, then M has no larger wheel as a minor, while if N is a whirl, then M has no larger whirl as a minor. Then there is a sequence M_0, M_1, \dots, M_n of 3-connected matroids with $M_0 \cong N$ and $M_n = M$ such that M_i is a single-element deletion or a single-element contraction of M_{i+1} for all $i \in \{0, 1, \dots, n-1\}$.*

For graphs, Seymour’s result reads as follows. A simple graph G is obtained from a simple graph H by splitting a vertex if H is obtained from G by contracting an edge (see [19]) with both endvertices of e having degree at least three in G .

THEOREM 8. [18] *Let H be a simple 3-connected minor of a simple 3-connected graph G such that if H is a wheel, then H is the largest wheel minor of G . Then a graph isomorphic to G can be obtained from H by repeatedly applying the operations of adding an edge between two nonadjacent vertices and splitting a vertex.*

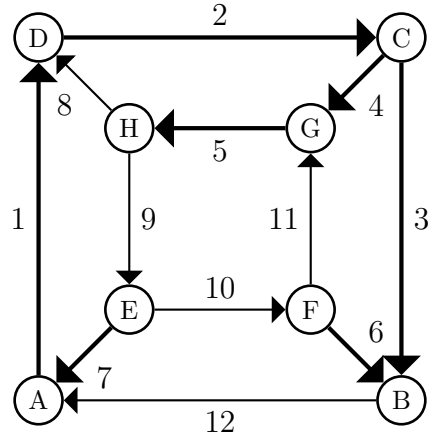

FIGURE 1.2. The Cube Graph

$$\begin{array}{c}
 \begin{matrix} -1 & -2 & -3 & -4 & -5 \\
 1 & \left[\begin{array}{ccccc}
 0 & 1 & -1 & 0 & 1 \\
 1 & 1 & -1 & 0 & 1 \\
 0 & 0 & -1 & 1 & 1 \\
 1 & 1 & 0 & -1 & 0 \\
 1 & 1 & 0 & 0 & 0 \\
 0 & 0 & 1 & -1 & 0 \\
 0 & 1 & -1 & 0 & 0 \end{array} \right]
 \end{matrix}
 \end{array}$$

FIGURE 1.3. Matrix Representation for Cube

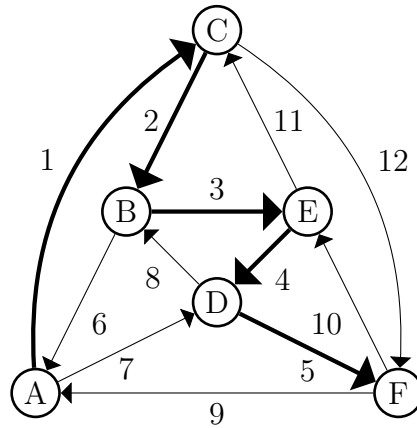

FIGURE 1.4. The Octahedron Graph

$$\begin{array}{c}
-1 \quad -2 \quad -3 \quad -4 \quad -5 \quad -6 \quad -7 \\
1 \left[\begin{array}{ccccccc}
1 & -1 & 0 & 1 & 0 & 0 & 0 \\
1 & -1 & 0 & 1 & 0 & 1 & -1 \\
0 & -1 & 1 & 1 & 0 & 1 & -1 \\
0 & -1 & 1 & 1 & 1 & 0 & -1 \\
0 & 0 & 0 & 1 & 1 & 0 & -1
\end{array} \right]
\end{array}$$

FIGURE 1.5. Matrix Representation for Octahedron

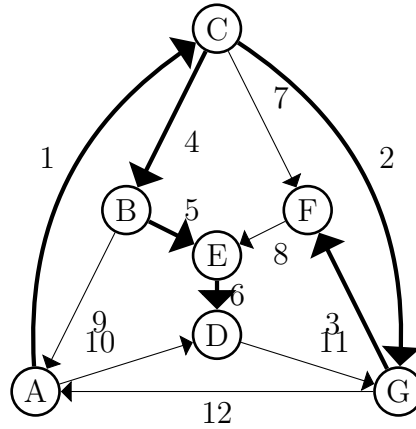

FIGURE 1.6. The Pyramid Graph

$$\begin{array}{c}
-1 \quad -2 \quad -3 \quad -4 \quad -5 \quad -6 \\
1 \left[\begin{array}{cccccc}
0 & 0 & 1 & -1 & 0 & 1 \\
-1 & 1 & 0 & 0 & -1 & 1 \\
-1 & 1 & 0 & 0 & 0 & 0 \\
0 & -1 & 1 & -1 & 1 & 0 \\
0 & -1 & 0 & -1 & 1 & 0 \\
0 & 0 & 0 & -1 & 1 & 0
\end{array} \right]
\end{array}$$

FIGURE 1.7. Matrix Representation for Pyramid

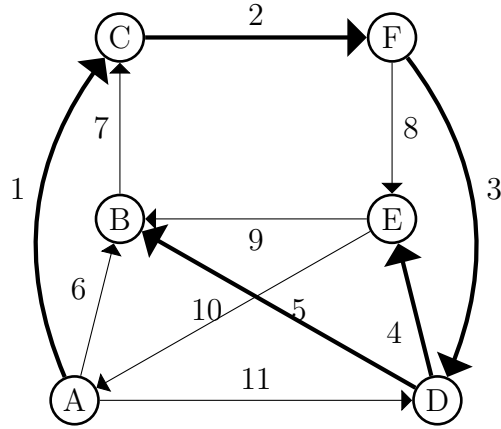

FIGURE 1.8. The Graph K_5^\perp

$$\begin{array}{c}
 \begin{matrix} -1 & -2 & -3 & -4 & -5 & -6 \\
 1 & \begin{bmatrix} -1 & 0 & 0 & 0 & 1 & -1 \\
 2 & \begin{bmatrix} -1 & 1 & 0 & 0 & 1 & -1 \\
 3 & \begin{bmatrix} -1 & 1 & -1 & 0 & 1 & -1 \\
 4 & \begin{bmatrix} 0 & 0 & -1 & 1 & 1 & 0 \\
 5 & \begin{bmatrix} -1 & 1 & 0 & -1 & 0 & 0 \end{bmatrix}
 \end{matrix}
 \end{matrix}
 \end{matrix}
 \end{array}$$

FIGURE 1.9. Matrix Representation for K_5^\perp

CHAPTER 2

Some New Ramsey Numbers

We use results of Ding and Liu, Oporowski, Oxley, and Thomas, and others to define some new Ramsey numbers associated with matroids in this section of the thesis. Some exact values and lower bounds for these numbers are computed in the last section of the thesis. For related asymptotic numbers to these values see [1]. The result that motivates this work is the following theorem of Oporowski, Oxley, and Thomas [14] (see also [2; 3] for other results of this type). The graph V_k is shown in Figure 2.1. The graph W_k is the wheel-graph with k spokes for $k \geq 3$, and the graph $K_{3,k}$ is the complete bipartite graph with partite classes of cardinality 3 and k , respectively.

THEOREM 9. *For every integer $k \geq 3$, there is an integer a_k such that every 3-connected simple graph with at least a_k vertices contains a subgraph isomorphic to a subdivision of one of W_k , V_k , and $K_{3,k}$.*

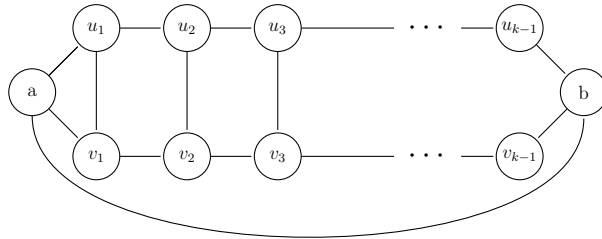

FIGURE 2.1. The Graph V_k

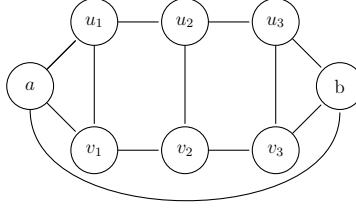

FIGURE 2.2. The Graph V_4

We now define some Ramsey numbers for classes of graphs \mathcal{C} . For most such classes \mathcal{C} , these numbers will not exist.

DEFINITION 3. *Let \mathcal{C} be a class of graphs and m be the fewest number of edges of a graph in \mathcal{C} . Then $N_{gr}(\mathcal{C})$ is the smallest positive integer exceeding $m - 1$ such that every 3-connected simple graph with at least $N_{gr}(\mathcal{C})$ edges contains a minor that is isomorphic to a member of \mathcal{C} (provided this number exists).*

We next show that the numbers $N_{gr}(\{W_k, K_{3,\ell}\})$ are well-defined for integers k and ℓ exceeding two. If the path v_1, v_2, \dots, v_{k-1} of V_k is contracted to a single vertex, then a graph isomorphic to W_{k+1} is obtained (see Figure 2.2 where the contraction of the edges (v_1, v_2) and (v_2, v_3) yields a graph that is isomorphic to W_5). So the graph V_k has a W_{k+1} -minor for all $k \in \{3, 4, 5, \dots\}$. A simple graph with at least $\binom{n-1}{2} + 1$ edges has at least n vertices. Thus the word “vertices” in Theorem 9 could be replaced by the word “edges”. Note that if a graph G contains a subgraph that is a subdivision of a graph H , then H is a minor of G . Larger wheels and bipartite graphs contain smaller wheels and bipartite graphs as minors. Hence it follows from Theorem 9 and these observations that the numbers $N_{gr}(\{W_k, K_{3,\ell}\})$ are well-defined for integers k and ℓ exceeding two.

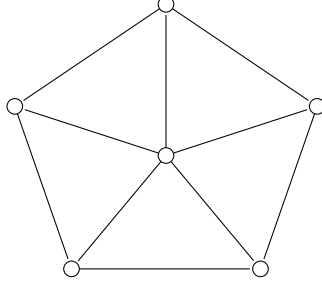

FIGURE 2.3. The Graph W_5

$$\left[\begin{array}{cccccc|cccccc} 1 & 0 & 0 & 0 & 0 & 0 & 0 & 1 & 1 & 1 & 1 & 1 \\ 0 & 1 & 0 & 0 & 0 & 0 & 1 & 0 & 1 & 1 & 1 & 1 \\ 0 & 0 & 1 & 0 & \cdots & 0 & 1 & 1 & 0 & 1 & \cdots & 1 \\ \vdots & 0 & 0 & 1 & \ddots & \vdots & \vdots & 1 & 1 & 0 & \ddots & \vdots \end{array} \right]$$

FIGURE 2.4. Matrix Representation for S_k

Ding, Oporowski, Oxley, and Vertigan [3] generalized Theorem 9 to binary matroids with the following result. A binary representation for S_k is $[I_k \mid D]$ where I_k is the $k \times k$ identity matrix and D is the $k \times k$ matrix with a zero on each diagonal entry and ones elsewhere (see Figure 2.4).

THEOREM 10. *For every integer k greater than two, there is an integer b_k such that every 3-connected binary matroid with more than b_k elements contains a minor isomorphic to one of $M(K_{3,k})$, $M^*(K_{3,k})$, $M(W_k)$, and S_k .*

As we defined some Ramsey numbers for graphs based on Theorem 9, we now define some Ramsey numbers for regular matroids based on Theorem 10. These numbers may be defined for regular matroids as a regular matroid is also a binary matroid. Again, for most classes of regular matroids \mathcal{C} these numbers will not exist.

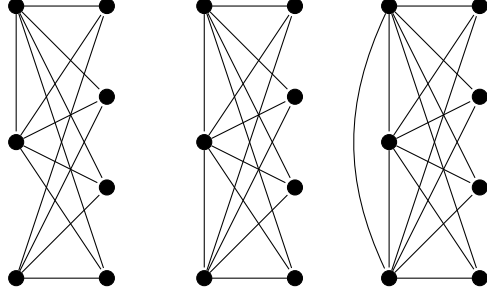

FIGURE 2.5. The Graphs $K'_{3,4}$, $K''_{3,4}$, and $K'''_{3,4}$

DEFINITION 4. Let \mathcal{C} be a class of regular matroids and m be the fewest number of elements of a matroid in \mathcal{C} . Let $N_{\text{reg}}(\mathcal{C})$ be the smallest positive integer exceeding $m - 1$ such that every 3-connected regular matroid with at least $N_{\text{reg}}(\mathcal{C})$ elements contains a minor that is isomorphic to a member of \mathcal{C} (provided this number exists).

The matroid S_k has a Fano-minor for k exceeding three and therefore is not regular. Hence Theorem 10 implies that the numbers $N_{\text{reg}}(\{M(K_{3,k}), M^*(K_{3,\ell}), M(W_m)\})$ are well-defined for integers k , ℓ , and m exceeding three. The previous two results are Ramsey in nature and not exact. The following exact result of Oxley is fundamental in the program of discovering exact values for Ramsey numbers.

THEOREM 11. Let G be a graph. Then G is simple and 3-connected having no W_5 -minor if and only if

- (1) $G \cong W_3$ or W_4 ;
- (2) G is isomorphic to a simple 3-connected minor of K_5^\perp , the cube, the octahedron, or the pyramid; or
- (3) for some $k \geq 3$, H is isomorphic to one of $K_{3,k}$, $K'_{3,k}$, $K''_{3,k}$, or $K'''_{3,k}$.

CHAPTER 3

Thesis Results

This section begins with five results of Ding, Dziobiak, and Wu on graphs that contain either a W_k or a $K_{3,t}$ minor. Then some related exact values and lower bounds to these results are given for small k and t . The first such result of Ding et al. establishes that a sufficiently large graph must have either a large wheel or a large complete bipartite graph as a minor.

THEOREM 12. [1] *If G is a k -connected graph ($k \geq 3$) on n vertices, then for any $\frac{1}{2} \leq c < 1$ and any integer $p \geq 1$, G has a W_s -minor with $s = \lfloor \frac{\sqrt{2c}}{12} \sqrt{\log(\log n)} \rfloor$, or a $K_{k,t}$ -minor with $t = \Omega((\log n)^p)$.*

We are particularly interested in 3-connected graphs and matroids in this work. Ding et al. sharpened the above result for such graphs as follows.

THEOREM 13. [1] *If G is a 3-connected graph on n vertices, then G has a $K_{3,t}$ -minor with $t = \Omega(\sqrt{\log n})$, or a W_k -minor with $k = \Omega(\sqrt{\log n})$.*

The next result of Ding, Dziobiak, and Wu found a large wheel-minor in a cubic graph.

THEOREM 14. [1] *Let G be a 3-connected planar or cubic graph on n vertices. Then G has a W_k -minor with $k = \lfloor \frac{\sqrt{(2c)}}{12} \sqrt{\log n} \rfloor$, where $0.63 < c < 0.7$ is a fixed constant.*

Finally, we give a result of Ding, Dziobiak, and Wu that finds a large bond (minimal edge-cut) in a 3-connected graph with many vertices.

THEOREM 15. [1] *If G is a 3-connected graph on n vertices, then $c^*(G) \geq \frac{1}{12}\sqrt{\log n}$ for sufficiently large n .*

The above results are all asymptotic in nature. We now compute some exact values of Ramsey numbers for graphs and matroids when possible. When it is not possible to compute the values precisely, we give lower bounds on these numbers so the results that follow complement the above results.

THEOREM 16. $N_{gr}(W_3) = 6$.

PROOF. It follows from the definition that $N_{gr}(W_3) \geq 6$. If G is a 3-connected simple graph, then Theorem 8 can be used to show that G has a wheel-minor with at least three spokes. Hence G has a W_3 -minor. Thus $N_{gr}(W_3) \leq 6$. Hence $N_{gr}(W_3) = 6$. \square

We obtain the following corollary to Theorem 16.

COROLLARY 1. *If \mathcal{C} is a class of 3-connected simple graphs that contains W_3 , then $N_{gr}(\mathcal{C}) = 6$.*

THEOREM 17. $N_{gr}(W_4) = 8$.

PROOF. It follows from the definition that $N_{gr}(W_4) \geq 8$. If G is a 3-connected simple graph with at least eight edges, then Theorem 8 implies that G has either a W_3 or a W_4 -minor.

If the latter does not hold, but the former does, then G has a minor that is isomorphic to a 3-connected simple graph obtained by adding an edge or splitting a vertex of the W_3 -minor.

There is no such graph. Hence $N_{\text{gr}}(W_4) \leq 8$. Thus $N_{\text{gr}}(W_4) = 8$. \square

We obtain the following corollary to Theorem 17.

COROLLARY 2. *If \mathcal{C} is a class of 3-connected simple graphs that contains W_4 but not W_3 , then $N_{\text{gr}}(\mathcal{C}) = 8$.*

An immediate consequence of Corollaries 1 and 2 is that $N_{\text{gr}}(\{V_3, W_3, K_{3,3}\}) = 6$ and $N_{\text{gr}}(\{V_4, W_4, K_{3,4}\}) = 8$. Thus $N_{\text{gr}}(\{W_3, K_{3,3}\}) = 6$ and $N_{\text{gr}}(\{W_4, K_{3,4}\}) = 8$. Notice that these two families of graphs are related to the cases $k = 3$ and $k = 4$ of Theorem 9. The next case of interest of Theorem 9 is the case $k = 5$. We will consider some related cases before determining this number. We now describe the use of MACEK [9] to calculate some matroid Ramsey numbers for graphs with more edges than those considered previously.

Consider the command (\dagger) used by the computer program MACEK [9]. The “-pREG ’!extend b” option yields the 3-connected regular extensions and coextensions M of a specified matroid. Here, the specified matroid is $M(W_4)$ as listed at the end of command \dagger . The options ext-forbid ”grK33;!dual” ”grK5;!dual” ensure that the regular matroid M has neither a $M^*(K_{3,3})$ - nor a $M^*(K_5)$ -minor. Hence the matroids M are graphic. The options “ext-forbid K34 W5” ensure that the matroid M has neither $M(K_{3,4})$ nor $M(W_5)$ as a minor. Hence this command gives all 3-connected graphic matroids with nine elements that are extensions or coextensions of $M(W_4)$ and that do not have $M(K_{3,4})$ and $M(W_5)$ as a

Line	Extending	Number of Extensions	Forbidding	\leq Size	Number of Matroids Produced
1	W_4	1	$K_{3,4}, W_5$	9	3
2		2		10	6
3		3		11	10
4		4		12	14
5		5		13	14
6	W_4	1	$K_{3,5}, W_5$	9	3
7		2		10	6
8		3		11	10
9		4		12	15
10		5		13	16
11		6		14	17
12		7		15	18
13		8		16	18
14	W_4	1	$K_{3,6}, W_5$	9	3
15		2		10	6
16		3		11	10
17		4		12	15
18		5		13	16
19		6		14	17
20		7		15	19
21		8		16	20
22		9		17	21
23		10		18	22
24		11		19	22

FIGURE 3.1. The 3-connected graphic Matroids with an $M(W_4)$ -minor but neither $M(W_5)$ nor $M(K_{3,n})$ as minors

minor. The “!print” option outputs matrix representations for all such matroids.

(†) -pREG '!extend b;@ext-forbid "grK33;!dual" "grK5;!dual" K34 W5;!print' W4

Consider the command ‡. This command is almost identical to command † except for the inclusion of the option “bb” versus the option “b”. This command gives all 3-connected graphic matroids that have $M(W_4)$ as a minor but do not have $M(K_{3,4})$ and $M(W_5)$ as a minor. In general, each extra option “b” in these two commands adds an extension and

coextension to the class of matroids previously generated.

(‡) -pREG '!extend bb;@ext-forbid "grK33;!dual" "grK5;!dual" K34 W5;!print' W4

Graphic and regular matroids that are 3-connected can be constructed from wheel-matroids with rank at least four by 3-connected extensions and coextensions. We produce the results in the table of Figure 3.1, and the tables in the figures that follow, by using commands such as that given in †. This table is interpreted as follows. Line 1 of the table yields the number of 3-connected graphs that are obtained by extensions and coextensions of W_4 with at most nine edges, but that have neither $K_{3,4}$ nor W_5 as a minor. There are three such graphs up to isomorphism. Line 2 of the table yields that there are six such graphs, so there are exactly $6 - 3 = 3$ graphs with ten edges that are 3-connected, constructed from W_4 by extensions and coextensions, and have neither $K_{3,4}$ nor W_5 as a minor. What is significant about the last column of lines 4 and 5 is that the numbers obtained in those cells are identical, namely 14. It follows that there are no 3-connected graphs with thirteen edges that are obtained from W_4 by extensions and coextensions that have neither $K_{3,4}$ nor W_5 as a minor. Moreover, by Seymour's Splitter theorem there are no such graphs with more than thirteen edges. We next give a result of Oxley from Theorem 11 in the matroid Ramsey notation and verify this result for some small values of n using MACEK [9].

THEOREM 18. $N_{gr}(W_5, K_{3,n}) = 3n + 1$ for $n \in \{4, 5, 6, \dots\}$.

PROOF. The graph $K'''_{3,n-1}$ is 3-connected and has no $K_{3,n}$ -minor for any $n \in \{4, 5, 6, \dots\}$. Thus $N_{gr}(W_5, K_{3,n}) \geq 3n + 1$. Suppose that G is a 3-connected graph with no W_5 -minor and no $K_{3,n}$ -minor for $n \in \{4, 5, 6, \dots\}$. It follows from Theorem 11 that either G has at most

Line	Extending	Number of Extensions	Forbidding	\leq Size	Number of Matroids Produced
1	W_5	1	$K_{3,4}, W_6$	11	3
2		2		12	19
3		3		13	59
4		4		14	148
5		5		15	282
6		6		16	397
7		7		17	454
8		8		18	467
9		9		19	471
10		10		20	472
11		11		21	472
12	W_5	1	$K_{3,5}, W_6$	11	3
13		2		12	19
14		3		13	61
15		4		14	159
16		5		15	318
17		6		16	465
18		7		17	547
19		8		18	576
20		9		19	586
21		10		20	589
22		11		21	590
23		12		22	590
24	W_5	1	$K_{3,6}, W_6$	11	3
25		2		12	19
26		3		13	61
27		4		14	159
28		5		15	319
29		6		16	472
30		7		17	574
31		8		18	647
32		9		19	716
33		10		20	783
34		11		21	842
35		12		22	882
36		13		23	CRASH

FIGURE 3.2. The 3-connected graphic Matroids with an $M(W_5)$ -minor but neither $M(W_6)$ nor $M(K_{3,n})$ as a minor.

twelve edges or G is isomorphic to $K_{3,k-1}$, $K'_{3,k-1}$, $K''_{3,k-1}$, or $K'''_{3,k-1}$ for some integer $k \leq n$.

Hence $N_{gr}(W_5, K_{3,n}) \leq 3n + 1$. □

The proof of Theorem 18 requires the use of Theorem 11. This theorem requires a six-page proof just for the graph case versus the regular matroid case. A quick proof of this result for the cases $n \in \{4, 5, 6\}$ using MACEK is obtained from the results of Lines 5, 13, and 24 of the table in Figure 3.1. MACEK cannot establish the previous result of Oxley for all n . However, results of that type are rare for graphs with nine or more edges so that the use of a computer becomes an essential tool. We can establish some further Matroid Ramsey numbers by consideration of the results of the table in Figure 3.2.

THEOREM 19.

(A) $N_{gr}(W_6, K_{3,4}) = 21$.

(B) $N_{gr}(W_6, K_{3,5}) = 22$.

(C) $N_{gr}(W_6, K_{3,6}) \geq 22$.

PROOF. The proofs of Theorem 19 (A), (B), (C) follow from Lines 11, 23, and 36 of the table in Figure 3.2, respectively. We should also note that consideration of extensions and coextensions of smaller wheels than those considered in this proof have been taken care of by the table in Figure 3.1. This pattern will be followed throughout the remainder of the thesis, where smaller wheels are considered before larger wheels in particular theorems. □

Line	Extending	Number of Extensions	Forbidding	\leq Size	Number of Matroids Produced
1	W_6	1	$K_{3,4}, W_7$	13	8
2		2		14	58
3		3		15	359
4		4		16	1594
5		5		17	5431
6		6		18	14734
7		7		running	
8	W_6	1	$K_{3,5}, W_7$	13	8
9		2		14	60
10		3		15	390
11		4		16	1832
12		5		17	6608
13		6		18	18460
14		7		running	
15	W_6	1	$K_{3,6}, W_7$	13	8
16		2		14	60
17		3		15	390
18		4		16	1840
19		5		17	6736
20		6		18	19629
20		7		running	

FIGURE 3.3. The 3-connected graphic Matroids with an $M(W_6)$ -minor but neither $M(W_7)$ nor $M(K_{3,n})$ as a minor

The natural extension of Theorem 19 is to exclude the graph W_7 instead of the graph W_6 . However, the results of the table in Figure 3.3 clearly indicate that it will be computational infeasible to produce such a result with the current resources.

We now move to the consideration of Matroid Ramsey numbers for regular matroids. It is interesting to contrast the results of Theorem 20 with those of Theorem 18.

Line	Extending	Number of Ex- tensions	Forbidding	\leq Size	Number of Ma- troids Pro- duced
1	W_4	1	$K_{3,4}, K_{3,4}^*, W_5$	9	4
2		2		10	10
3		3		11	16
4		4		12	21
5		5		13	21
6	W_4	1	$K_{3,5}, K_{3,5}^*, W_5$	9	4
7		2		10	10
8		3		11	16
9		4		12	23
10		5		13	25
11		6		14	27
12		7		15	29
13		8		16	29
14	W_4	1	$K_{3,6}, K_{3,6}^*, W_5$	9	4
15		2		10	10
16		3		11	16
17		4		12	23
18		5		13	25
19		6		14	27
20		7		15	31
21		8		16	33
22		9		17	35
23		10		18	37
24		11		19	37

FIGURE 3.4. The 3-connected regular Matroids with an $M(W_4)$ -minor but no $M(K_{3,k}), M(K_{3,k})^*$, and $M(W_5)$ minors

THEOREM 20. $N_{reg}(M(W_5), M(K_{3,n}), M^*(K_{3,n})) = 3n + 1$ for $n \in \{4, 5, 6\}$.

PROOF. The proof of this theorem can be found on Lines 5, 13, and 24 of the table in

Figure 3.4. □

We next explore the limits of the currently available software and computing power in the final result of the thesis. These limits are suggested by the results that follow Line 11 in the table in Figure 3.5 and the results in the table in Figure 3.6.

THEOREM 21. $N_{reg}(M(W_6), M(K_{3,4}), M^*(K_{3,4})) = 21$.

PROOF. This follows from Line 11 of the table in Figure 3.5. □

We have investigated extensions and coextensions for both graphic and regular matroids with as many as twenty-two elements. We have established that certain minors must appear in several classes of these matroids. Thus Ramsey theory for matroid minors is a promising area of research as the computer software and hardware tools develop as well as the matroid connectivity theory needed to support these computations. A further area of research would be to extend the theorems considered from the classes of graphic and regular matroids to the class of binary matroids. More processing capability will be needed for this effort because this class is much larger than the two classes considered here.

Line	Extending	Number of Ex- tensions	Forbidding	\leq Size	Number of Ma- troids Pro- duced
1	W_5	1	$K_{3,4}, K_{3,4}^*, W_6$	11	4
2		2		12	29
3		3		13	95
4		4		14	243
5		5		15	463
6		6		16	641
7		7		17	727
8		8		18	754
9		9		19	1762
10		10		20	764
11		11		21	764
12	W_5	1	$K_{3,5}, K_{3,5}^*, W_6$	11	4
13		2		12	29
14		3		13	99
15		4		14	265
16		5		15	537
17		6		16	785
18		7		17	931
19		8		18	1005
20		9		19	1037
21		10		20	1051
22		11		21	1061
23		12		22	1065
24		12		23	CRASH
25	W_5	1	$K_{3,6}, K_{3,6}^*, W_6$	11	4
26		2		12	29
27		3		13	99
28		4		14	265
29		5		15	539
30		6		16	799
31		7		17	987
32		8		18	1155
33		9		19	1315
34		10		20	1471
35		11		21	running

FIGURE 3.5. The 3-connected regular Matroids with an $M(W_5)$ -minor but no $M(K_{3,k})$, $M(K_{3,k})^*$, and $M(W_6)$ minors

Line	Extending	Number of Ex- tensions	Forbidding	\leq Size	Number of Ma- troids Pro- duced
1	W_6	1	$K_{3,4}, K_{3,4}^*, W_7$	13	12
2		2		14	99
3		3		15	655
4		4		16	2999
5		5		17	10399
6		6		18	CRASH
7	W_6	1	$K_{3,5}, K_{3,5}^*, W_7$	13	12
8		2		14	103
9		3		15	719
10		4		16	3491
11		5		17	12847
12		6		18	CRASH
13	W_6	1	$K_{3,6}, K_{3,6}^*, W_7$	13	12
14		2		14	103
15		3		15	719
16		4		16	3507
17		5		17	13109
18		6		18	running

FIGURE 3.6. The 3-connected regular Matroids with an $M(W_6)$ -minor but no $M(K_{3,k}), M(K_{3,k})^*$, and $M(W_6)$ minors

Bibliography

Bibliography

- [1] G. Ding, S. Dziobiak, and H. Wu, *Large W_k - or $K_{3,t}$ -minors in 3-connected graphs*, submitted.
- [2] Guoli Ding, Bogdan Oporowski, James Oxley, and Dirk Vertigan, *Unavoidable minors of large 3-connected binary matroids.*, *Journal of Combinatorial Theory - Series B* **66** (1996), no. 2, 334.
- [3] Guoli Ding, Bogdan Oporowski, James Oxley, and Dirk Vertigan, *Unavoidable minors of large 3-connected matroids.*, *Journal of Combinatorial Theory, Series B* **71** (n.d.), 244 – 293.
- [4] W. T. Tutte, *A theory of 3-connected graphs*, *Indagationes Mathematicae*, **23** (1961), 441-455.
- [5] P. Erdős and G. Szekeres, *A combinatorial problem in geometry*, *Compositio Math.* **2** (1935), 463–470.
- [6] Jack E. Graver and James Yackel, *Some graph theoretic results associated with Ramsey's theorem*, *J. Combinatorial Theory* **4** (1968), 125–175.
- [7] R. E. Greenwood and A. M. Gleason, *Combinatorial relations and chromatic graphs*, *Canad. J. Math.* **7** (1955), 1–7.

- [8] Charles M. Grinstead and Sam M. Roberts, *On the Ramsey numbers $R(3, 8)$ and $R(3, 9)$* , J. Combin. Theory Ser. B **33** (1982), no. 1, 27–51.
- [9] Petr Hliněný, *The macek program: Version 1.2+*, <http://www.mcs.vuw.ac.nz/research/macek/2002>.
- [10] J. G. Kalbfleisch, *On an unknown Ramsey number*, Michigan Math. J. **13** (1966), 385–392.
- [11] Manoel Lemos and James Oxley, *A sharp bound on the size of a connected matroid*, Trans. Amer. Math. Soc. **353** (2001), no. 10, 4039–4056.
- [12] Brendan D. McKay and Zhang Ke Min, *The value of the Ramsey number $R(3, 8)$* , J. Graph Theory **16** (1992), no. 1, 99–105.
- [13] Brendan D. McKay and Stanisław P. Radziszowski, *$R(4, 5) = 25$* , J. Graph Theory **19** (1995), no. 3, 309–322.
- [14] Bogdan Oporowski, James Oxley, and Robin Thomas, *Typical subgraphs of 3- and 4-connected graphs*, J. Combin. Theory Ser. B **57** (1993), no. 2, 239–257.
- [15] James G. Oxley, *Matroid theory*, second ed., Oxford Graduate Texts in Mathematics, vol. 21, Oxford University Press, Oxford, 2011.
- [16] James G. Oxley, *Matroid Theory*, Oxford University Press, 1992.
- [17] Talmage James Reid, *Ramsey numbers for matroids*, European J. Combin. **18** (1997), no. 5, 589–595.
- [18] P. D. Seymour, *Decomposition of regular matroids*, J. Combin. Theory Ser. B **28** (1980), no. 3, 305–359.

- [19] Robin Thomas, *Recent excluded minor theorems for graphs*, Surveys in combinatorics, 1999 (Canterbury), London Math. Soc. Lecture Note Ser., vol. 267, Cambridge Univ. Press, Cambridge, 1999, pp. 201–222.
- [20] W. T. Tutte, *Lectures on matroids*, J. Res. Nat. Bur. Standards Sect. B **69B** (1965), 1–47.
- [21] K. Wagner, *Über eine Eigenschaft der ebenen Komplexe*, Math. Ann. **114** (1937), no. 1, 570–590.
- [22] Douglas West, *Introduction to Graph Theory*, Prentice-Hall, 2001.
- [23] Pou-Lin Wu, *Extremal graphs with prescribed circumference and cocircumference*, Discrete Math. **223** (2000), no. 1-3, 299–308.
- [24] W. T. Tutte, *A Homotopy Theorem for Matroids, I*, Transactions of the American Mathematical Society, **88** (1958), pp. 144-160.

List of Appendices

Appendix A: Results From Graphic Extensions of W_4

Results From Graphic Extensions of W_4

Forbidding $K_{3,3}$ and W_5				
Script	Sequoia Job	Command	Matroid Size	Number of Matroids Produced
ext_1_gr.pbs	126532	<code>-pREG '!extend b;@ext-forbid "grK33;!dual" "grK5;!dual" grK33 W5;!print' W4</code>	9	2
ext_2_gr.pbs	126534	<code>-pREG '!extend bb;@ext-forbid "grK33;!dual" "grK5;!dual" grK33 W5;!print' W4</code>	10	4
ext_3_gr.pbs	126535	<code>-pREG '!extend bbb;@ext-forbid "grK33;!dual" "grK5;!dual" grK33 W5;!print' W4</code>	11	6
ext_4_gr.pbs	126536	<code>-pREG '!extend bbbb;@ext-forbid "grK33;!dual" "grK5;!dual" grK33 W5;!print' W4</code>	12	9
ext_5_gr.pbs	126538	<code>-pREG '!extend bbbbb;@ext-forbid "grK33;!dual" "grK5;!dual" grK33 W5;!print' W4</code>	13	9
Forbidding $K_{3,4}$ and W_5				
Script	Sequoia Job	Command	Matroid Size	Number of Matroids Produced
ext_1_gr.pbs	125960	<code>-pREG '!extend b;@ext-forbid "grK33;!dual" "grK5;!dual" K34 W5;!print' W4</code>	9	3
ext_2_gr.pbs	125961	<code>-pREG '!extend bb;@ext-forbid "grK33;!dual" "grK5;!dual" K34 W5;!print' W4</code>	10	6
ext_3_gr.pbs	104644	<code>-pREG '!extend bbb;@ext-forbid "grK33;!dual" "grK5;!dual" K34 W5;!print' W4</code>	11	10
ext_4_gr.pbs	104645	<code>-pREG '!extend bbbb;@ext-forbid "grK33;!dual" "grK5;!dual" K34 W5;!print' W4</code>	12	14
ext_5_gr.pbs	117669	<code>-pREG '!extend bbbbb;@ext-forbid "grK33;!dual" "grK5;!dual" K34 W5;!print' W4</code>	13	14

Forbidding $K_{3,5}$ and W_5				
Script	Sequoia Job	Command	Matroid Size	Number of Matroids Produced
ext_1_gr_more.pbs	123412	-pREG '!extend b;@ext-forbid "grK33;!dual" "grK5;!dual" K35 W5;!print' W4	9	3
ext_2_gr_more.pbs	123413	-pREG '!extend bb;@ext-forbid "grK33;!dual" "grK5;!dual" K35 W5;!print' W4	10	6
ext_3_gr_more.pbs	123414	-pREG '!extend bbb;@ext-forbid "grK33;!dual" "grK5;!dual" K35 W5;!print' W4	11	10
ext_4_gr_more.pbs	123415	-pREG '!extend bbbb;@ext-forbid "grK33;!dual" "grK5;!dual" K35 W5;!print' W4	12	15
ext_5_gr_more.pbs	123416	-pREG '!extend bbbbb;@ext-forbid "grK33;!dual" "grK5;!dual" K35 W5;!print' W4	13	16
ext_6_gr_more.pbs	123417	-pREG '!extend bbbbbb;@ext-forbid "grK33;!dual" "grK5;!dual" K35 W5;!print' W4	14	17
ext_7_gr_more.pbs	123418	-pREG '!extend bbbbbbb;@ext-forbid "grK33;!dual" "grK5;!dual" K35 W5;!print' W4	15	18
ext_8_gr_more.pbs	123419	-pREG '!extend bbbbbbbb;@ext-forbid "grK33;!dual" "grK5;!dual" K35 W5;!print' W4	16	18
Forbidding $K_{3,6}$ and W_5				
Script	Sequoia Job	Command	Matroid Size	Number of Matroids Produced
ext_1_gr_no_w7.pbs	123424	-pREG '!extend b;@ext-forbid "grK33;!dual" "grK5;!dual" K36 W5;!print' W4	9	3
ext_2_gr_no_w7.pbs	123425	-pREG '!extend bb;@ext-forbid "grK33;!dual" "grK5;!dual" K36 W5;!print' W4	10	6
ext_3_gr_no_w7.pbs	125962	-pREG '!extend bbb;@ext-forbid "grK33;!dual" "grK5;!dual" K36 W5;!print' W4	11	10
ext_4_gr_no_w7.pbs	125964	-pREG '!extend bbbb;@ext-forbid "grK33;!dual" "grK5;!dual" K36 W5;!print' W4	12	15
ext_5_gr_no_w7.pbs	125965	-pREG '!extend bbbbb;@ext-forbid "grK33;!dual" "grK5;!dual" K36 W5;!print' W4	13	16
ext_6_gr_no_w7.pbs	125966	-pREG '!extend bbbbbb;@ext-forbid "grK33;!dual" "grK5;!dual" K36 W5;!print' W4	14	17
ext_7_gr_no_w7.pbs	125967	-pREG '!extend bbbbbbb;@ext-forbid "grK33;!dual" "grK5;!dual" K36 W5;!print' W4	15	19
ext_8_gr_no_w7.pbs	125968	-pREG '!extend bbbbbbbb;@ext-forbid "grK33;!dual" "grK5;!dual" K36 W5;!print' W4	16	20
ext_9_gr_no_w7.pbs	125969	-pREG '!extend bbbbbbbbbb;@ext-forbid "grK33;!dual" "grK5;!dual" K36 W5;!print' W4	17	21
ext_10_gr_no_w7.pbs	125976	-pREG '!extend bbbbbbbbbb;@ext-forbid "grK33;!dual" "grK5;!dual" K36 W5;!print' W4	18	22
ext_11_gr_no_w7.pbs	125977	-pREG '!extend bbbbbbbbbb;@ext-forbid "grK33;!dual" "grK5;!dual" K36 W5;!print' W4	19	22

Appendix B: Results From Graphic Extensions of W_5

Results From Graphic Extensions of W_5

Forbidding $K_{3,4}$ and W_6				
Script	Sequoia Job	Command	Matroid Size	Number of Matroids Produced
ext_1_nok34w6.pbs	123763	-pREG '!extend b;@ext-forbid "grK33;!dual" "grK5;!dual" K34 W6;!print' W5	11	3
ext_2_nok34w6.pbs	123764	-pREG '!extend bb;@ext-forbid "grK33;!dual" "grK5;!dual" K34 W6;!print' W5	12	19
ext_3_nok34w6.pbs	123765	-pREG '!extend bbb;@ext-forbid "grK33;!dual" "grK5;!dual" K34 W6;!print' W5	13	59
ext_4_nok34w6.pbs	123766	-pREG '!extend bbbb;@ext-forbid "grK33;!dual" "grK5;!dual" K34 W6;!print' W5	14	148
ext_5_nok34w6.pbs	123767	-pREG '!extend bbbbb;@ext-forbid "grK33;!dual" "grK5;!dual" K34 W6;!print' W5	15	282
ext_6_nok34w6.pbs	123770	-pREG '!extend bbbbbb;@ext-forbid "grK33;!dual" "grK5;!dual" K34 W6;!print' W5	16	397
ext_7_nok34w6.pbs	123771	-pREG '!extend bbbbbbb;@ext-forbid "grK33;!dual" "grK5;!dual" K34 W6;!print' W5	17	454
ext_8_nok34w6.pbs	123772	-pREG '!extend bbbbbbbb;@ext-forbid "grK33;!dual" "grK5;!dual" K34 W6;!print' W5	18	467
ext_9_nok34w6.pbs	123785	-pREG '!extend bbbbbbbbbb;@ext-forbid "grK33;!dual" "grK5;!dual" K34 W6;!print' W5	19	471
ext_10_nok34w6.pbs	123787	-pREG '!extend bbbbbbbbbb;@ext-forbid "grK33;!dual" "grK5;!dual" K34 W6;!print' W5	20	472
ext_11_nok34w6.pbs	123788	-pREG '!extend bbbbbbbbbb;@ext-forbid "grK33;!dual" "grK5;!dual" K34 W6;!print' W5	21	472

Forbidding $K_{3,5}$ and W_5				
Script	Sequoia Job	Command	Matroid Size	Number of Matroids Produced
ext_1_gr.pbs	104735	-pREG '!extend b;@ext-forbid "grK33;!dual" "grK5;!dual" K35 W6;!print' W5	11	3
ext_2_gr.pbs	104736	-pREG '!extend bb;@ext-forbid "grK33;!dual" "grK5;!dual" K35 W6;!print' W5	12	19
ext_3_gr.pbs	104737	-pREG '!extend bbb;@ext-forbid "grK33;!dual" "grK5;!dual" K35 W6;!print' W5	13	61
ext_4_gr.pbs	104738	-pREG '!extend bbbb;@ext-forbid "grK33;!dual" "grK5;!dual" K35 W6;!print' W5	14	159
ext_5_gr.pbs	104739	-pREG '!extend bbbbb;@ext-forbid "grK33;!dual" "grK5;!dual" K35 W6;!print' W5	15	318
ext_6_gr.pbs	104839	-pREG '!extend bbbbbb;@ext-forbid "grK33;!dual" "grK5;!dual" K35 W6;!print' W5	16	465
ext_7_gr.pbs	104740	-pREG '!extend bbbbbbb;@ext-forbid "grK33;!dual" "grK5;!dual" K35 W6;!print' W5	17	547
ext_8_gr.pbs	104840	-pREG '!extend bbbbbbbb;@ext-forbid "grK33;!dual" "grK5;!dual" K35 W6;!print' W5	18	576
ext_9_gr.pbs	104841	-pREG '!extend bbbbbbbbb;@ext-forbid "grK33;!dual" "grK5;!dual" K35 W6;!print' W5	19	586
ext_10_gr.pbs	105056	-pREG '!extend bbbbbbbbbb;@ext-forbid "grK33;!dual" "grK5;!dual" K35 W6;!print' W5	20	589
ext_11_gr.pbs	105057	-pREG '!extend bbbbbbbbbbb;@ext-forbid "grK33;!dual" "grK5;!dual" K35 W6;!print' W5	21	590
ext_12_gr.pbs	105156	-pREG '!extend bbbbbbbbbbbb;@ext-forbid "grK33;!dual" "grK5;!dual" K35 W6;!print' W5	22	590

Forbidding $K_{3,6}$ and W_6				
Script	Sequoia Job	Command	Matroid Size	Number of Matroids Produced
ext_1_gr_nok36w6.pbs	123790	-pREG '!extend b;@ext-forbid "grK33;!dual" "grK5;!dual" K36 W6;!print' W5	11	3
ext_2_gr_nok36w6.pbs	123792	-pREG '!extend bb;@ext-forbid "grK33;!dual" "grK5;!dual" K36 W6;!print' W5	12	19
ext_3_gr_nok36w6.pbs	123794	-pREG '!extend bbb;@ext-forbid "grK33;!dual" "grK5;!dual" K36 W6;!print' W5	13	61
ext_4_gr_nok36w6.pbs	123795	-pREG '!extend bbbb;@ext-forbid "grK33;!dual" "grK5;!dual" K36 W6;!print' W5	14	159
ext_5_gr_nok36w6.pbs	123797	-pREG '!extend bbbbb;@ext-forbid "grK33;!dual" "grK5;!dual" K36 W6;!print' W5	15	319
ext_6_gr_nok36w6.pbs	123798	-pREG '!extend bbbbbb;@ext-forbid "grK33;!dual" "grK5;!dual" K36 W6;!print' W5	16	472
ext_7_gr_nok36w6.pbs	123799	-pREG '!extend bbbbbbb;@ext-forbid "grK33;!dual" "grK5;!dual" K36 W6;!print' W5	17	574
ext_8_gr_nok36w6.pbs	123800	-pREG '!extend bbbbbbbb;@ext-forbid "grK33;!dual" "grK5;!dual" K36 W6;!print' W5	18	647
ext_9_gr_nok36w6.pbs	123801	-pREG '!extend bbbbbbbbb;@ext-forbid "grK33;!dual" "grK5;!dual" K36 W6;!print' W5	19	716
ext_10_gr_nok36w6.pbs	123885	-pREG '!extend bbbbbbbbbb;@ext-forbid "grK33;!dual" "grK5;!dual" K36 W6;!print' W5	20	783
ext_11_gr_nok36w6.pbs	123887	-pREG '!extend bbbbbbbbbbb;@ext-forbid "grK33;!dual" "grK5;!dual" K36 W6;!print' W5	21	842
ext_12_gr_nok36w6.pbs	124257	-pREG '!extend bbbbbbbbbbbb;@ext-forbid "grK33;!dual" "grK5;!dual" K36 W6;!print' W5	22	882
ext_13_gr_nok36w6.pbs	126138	-pREG '!extend bbbbbbbbbbbb;@ext-forbid "grK33;!dual" "grK5;!dual" K36 W6;!print' W5	23	MACEK crashed

Appendix C: Results From Graphic Extensions of W_6

Results From Graphic Extensions of W_6

Forbidding $K_{3,4}$ and W_7				
Script	Sequoia Job	Command	Matroid Size	Number of Matroids Produced
ext_1_gr_nok34w7.pbs	123890	-pREG '!extend b;@ext-forbid "grK33;!dual" "grK5;!dual" K34 W7;!print' W6	13	8
ext_2_gr_nok34w7.pbs	123892	-pREG '!extend bb;@ext-forbid "grK33;!dual" "grK5;!dual" K34 W7;!print' W6	14	58
ext_3_gr_nok34w7.pbs	123893	-pREG '!extend bbb;@ext-forbid "grK33;!dual" "grK5;!dual" K34 W7;!print' W6	15	359
ext_4_gr_nok34w7.pbs	123896	-pREG '!extend bbbb;@ext-forbid "grK33;!dual" "grK5;!dual" K34 W7;!print' W6	16	1594
ext_5_gr_nok34w7.pbs	123897	-pREG '!extend bbbbb;@ext-forbid "grK33;!dual" "grK5;!dual" K34 W7;!print' W6	17	5431
ext_6_gr_nok34w7.pbs	124012	-pREG '!extend bbbbbb;@ext-forbid "grK33;!dual" "grK5;!dual" K34 W7;!print' W6	18	14734
ext_7_gr_nok34w7.pbs	126781	-pREG '!extend bbbbbbb;@ext-forbid "grK33;!dual" "grK5;!dual" K34 W7;!print' W6	19	running
Forbidding $K_{3,5}$ and W_7				
Script	Sequoia Job	Command	Matroid Size	Number of Matroids Produced
ext_1_gr_nok35w7.pbs	124013	-pREG '!extend b;@ext-forbid "grK33;!dual" "grK5;!dual" K35 W7;!print' W6	13	8
ext_2_gr_nok35w7.pbs	124014	-pREG '!extend bb;@ext-forbid "grK33;!dual" "grK5;!dual" K35 W7;!print' W6	14	60
ext_3_gr_nok35w7.pbs	124015	-pREG '!extend bbb;@ext-forbid "grK33;!dual" "grK5;!dual" K35 W7;!print' W6	15	390
ext_4_gr_nok35w7.pbs	124016	-pREG '!extend bbbb;@ext-forbid "grK33;!dual" "grK5;!dual" K35 W7;!print' W6	16	1832
ext_5_gr_nok35w7.pbs	124020	-pREG '!extend bbbbb;@ext-forbid "grK33;!dual" "grK5;!dual" K35 W7;!print' W6	17	6608
ext_6_gr_nok35w7.pbs	124152	-pREG '!extend bbbbbb;@ext-forbid "grK33;!dual" "grK5;!dual" K35 W7;!print' W6	18	18640
ext_7_gr_nok35w7.pbs	127905	-pREG '!extend bbbbbbb;@ext-forbid "grK33;!dual" "grK5;!dual" K35 W7;!print' W6	19	running

Forbidding $K_{3,6}$ and W_7				
Script	Sequoia Job	Command	Matroid Size	Number of Matroids Produced
ext_1_gr.pbs	107735	-pREG '!extend b;@ext-forbid "grK33;!dual" "grK5;!dual" K36 W7;!print' W6	13	8
ext_2_gr.pbs	107736	-pREG '!extend bb;@ext-forbid "grK33;!dual" "grK5;!dual" K36 W7;!print' W6	14	60
ext_3_gr.pbs	107737	-pREG '!extend bbb;@ext-forbid "grK33;!dual" "grK5;!dual" K36 W7;!print' W6	15	390
ext_4_gr.pbs	107739	-pREG '!extend bbbb;@ext-forbid "grK33;!dual" "grK5;!dual" K36 W7;!print' W6	16	1840
ext_5_gr.pbs	107741	-pREG '!extend bbbbb;@ext-forbid "grK33;!dual" "grK5;!dual" K36 W7;!print' W6	17	6736
ext_6_gr.pbs	107742	-pREG '!extend bbbbbb;@ext-forbid "grK33;!dual" "grK5;!dual" K36 W7;!print' W6	18	19629
ext_7_gr.pbs	117672	-pREG '!extend bbbbbbb;@ext-forbid "grK33;!dual" "grK5;!dual" K36 W7;!print' W6	19	running

Appendix D: Results From Regular Extensions of W_4

Results From Regular Extensions of W_4

Forbidding $K_{3,3}$, $K_{3,3}^*$ and W_5				
Script	Sequoia Job	Command	Matroid Size	Number of Matroids Produced
ext_1_reg.pbs	126988	-pREG '!extend b;@ext-forbid "K33;!dual" K33 W5;!print' W4	9	2
ext_2_reg.pbs	126989	-pREG '!extend bb;@ext-forbid "K33;!dual" K33 W5;!print' W4	10	5
ext_3_reg.pbs	126990	-pREG '!extend bbb;@ext-forbid "K33;!dual" K33 W5;!print' W4	11	7
ext_4_reg.pbs	126991	-pREG '!extend bbbb;@ext-forbid "K33;!dual" K33 W5;!print' W4	12	10
ext_5_reg.pbs	126992	-pREG '!extend bbbbb;@ext-forbid "K33;!dual" " K33 W5;!print' W4	13	10
Forbidding $K_{3,4}$, $K_{3,4}^*$ and W_5				
Script	Sequoia Job	Command	Matroid Size	Number of Matroids Produced
ext_1_reg.pbs	124565	-pREG '!extend b;@ext-forbid "K34;!dual" K34 W5;!print' W4	9	4
ext_2_reg.pbs	124566	-pREG '!extend bb;@ext-forbid "K34;!dual" K34 W5;!print' W4	10	10
ext_3_reg.pbs	124568	-pREG '!extend bbb;@ext-forbid "K34;!dual" K34 W5;!print' W4	11	16
ext_4_reg.pbs	124569	-pREG '!extend bbbb;@ext-forbid "K34;!dual" K34 W5;!print' W4	12	21
ext_5_reg.pbs	124570	-pREG '!extend bbbbb;@ext-forbid "K34;!dual" " K34 W5;!print' W4	13	21

Forbidding $K_{3,5}$, $K_{3,5}^*$ and W_5				
Script	Sequoia Job	Command	Matroid Size	Number of Matroids Produced
ext_1_reg.pbs	124573	-pREG '!extend b;@ext-forbid "K35;!dual" K35 W5;!print' W4	9	4
ext_2_reg.pbs	124595	-pREG '!extend bb;@ext-forbid "K35;!dual" K35 W5;!print' W4	10	10
ext_3_reg.pbs	124596	-pREG '!extend bbb;@ext-forbid "K35;!dual" K35 W5;!print' W4	11	16
ext_4_reg.pbs	124597	-pREG '!extend bbbb;@ext-forbid "K35;!dual" K35 W5;!print' W4	12	23
ext_5_reg.pbs	124598	-pREG '!extend bbbbb;@ext-forbid "K35;!dual" " K35 W5;!print' W4	13	25
ext_6_reg.pbs	124599	-pREG '!extend bbbbbb;@ext-forbid "K35;!dual" K35 W5;!print' W4	14	27
ext_7_reg.pbs	124600	-pREG '!extend bbbbbbb;@ext-forbid "K35;!dual" K35 W5;!print' W4	15	29
ext_8_reg.pbs	124600	-pREG '!extend bbbbbbbb;@ext-forbid "K35;!dual" K35 W5;!print' W4	16	29
Forbidding $K_{3,6}$, $K_{3,6}^*$ and W_5				
Script	Sequoia Job	Command	Matroid Size	Number of Matroids Produced
ext_1_reg.pbs	124602	-pREG '!extend b;@ext-forbid "K36;!dual" K36 W5;!print' W4	9	4
ext_2_reg.pbs	124603	-pREG '!extend bb;@ext-forbid "K36;!dual" K36 W5;!print' W4	10	10
ext_3_reg.pbs	124604	-pREG '!extend bbb;@ext-forbid "K36;!dual" K36 W5;!print' W4	11	16
ext_4_reg.pbs	124605	-pREG '!extend bbbb;@ext-forbid "K36;!dual" K36 W5;!print' W4	12	23
ext_5_reg.pbs	124606	-pREG '!extend bbbbb;@ext-forbid "K36;!dual" " K36 W5;!print' W4	13	25
ext_6_reg.pbs	124609	-pREG '!extend bbbbbb;@ext-forbid "K36;!dual" K36 W5;!print' W4	14	27
ext_7_reg.pbs	104610	-pREG '!extend bbbbbbb;@ext-forbid "K36;!dual" K36 W5;!print' W4	15	31
ext_8_reg.pbs	124611	-pREG '!extend bbbbbbbb;@ext-forbid "K36;!dual" K36 W5;!print' W4	16	33
ext_9_reg.pbs	124612	-pREG '!extend bbbbbbbbbb;@ext-forbid "K36;!dual" K36 W5;!print' W4	17	35
ext_10_reg.pbs	124614	-pREG '!extend bbbbbbbbbb;@ext-forbid "K36;!dual" K36 W5;!print' W4	18	37
ext_11_reg.pbs	124616	-pREG '!extend bbbbbbbbbb;@ext-forbid "K36;!dual" K36 W5;!print' W4	19	37

Appendix E: Results From Regular Extensions of W_5

Results From Regular Extensions of W_5

Forbidding $K_{3,4}$, $K_{3,4}^*$ and W_6				
Script	Sequoia Job	Command	Matroid Size	Number of Matroids Produced
ext_1_reg.pbs	124672	-pREG '!extend b;@ext-forbid "K34;!dual" K34 W6;!print' W5	11	4
ext_2_reg.pbs	124673	-pREG '!extend bb;@ext-forbid "K34;!dual" K34 W6;!print' W5	12	29
ext_3_reg.pbs	124674	-pREG '!extend bbb;@ext-forbid "K34;!dual" K34 W6;!print' W5	13	95
ext_4_reg.pbs	124677	-pREG '!extend bbbb;@ext-forbid "K34;!dual" K34 W6;!print' W5	14	243
ext_5_reg.pbs	124681	-pREG '!extend bbbbb;@ext-forbid "K34;!dual" " K34 W6;!print' W5	15	463
ext_6_reg.pbs	124682	-pREG '!extend bbbbbb;@ext-forbid "K34;!dual" K34 W6;!print' W5	16	641
ext_7_reg.pbs	124879	-pREG '!extend bbbbbbb;@ext-forbid "K34;!dual" K34 W6;!print' W5	17	727
ext_8_reg.pbs	125301	-pREG '!extend bbbbbbbb;@ext-forbid "K34;!dual" K34 W6;!print' W5	18	754
ext_9_reg.pbs	126139	-pREG '!extend bbbbbbbbbb;@ext-forbid "K34;!dual" K34 W6;!print' W5	19	762
ext_10_reg.pbs	126436	-pREG '!extend bbbbbbbbbbb;@ext-forbid "K34;!dual" K34 W6;!print' W5	20	764
ext_11_reg.pbs	126782	-pREG '!extend bbbbbbbbbbbb;@ext-forbid "K34;!dual" K34 W6;!print' W5	21	764

Forbidding $K_{3,5}$, $K_{3,5}^*$ and W_6				
Script	Sequoia Job	Command	Matroid Size	Number of Matroids Produced
ext_1_reg.pbs	124692	-pREG '!extend b;@ext-forbid "K35;!dual" K35 W6;!print' W5	11	4
ext_2_reg.pbs	124695	-pREG '!extend bb;@ext-forbid "K35;!dual" K35 W6;!print' W5	12	29
ext_3_reg.pbs	124697	-pREG '!extend bbb;@ext-forbid "K35;!dual" K35 W6;!print' W5	13	99
ext_4_reg.pbs	124699	-pREG '!extend bbbb;@ext-forbid "K35;!dual" K35 W6;!print' W5	14	265
ext_5_reg.pbs	124702	-pREG '!extend bbbbb;@ext-forbid "K35;!dual" " K35 W6;!print' W5	15	537
ext_6_reg.pbs	124703	-pREG '!extend bbbbbb;@ext-forbid "K35;! dual" K35 W6;!print' W5	16	785
ext_7_reg.pbs	124880	-pREG '!extend bbbbbbb;@ext-forbid "K35;! dual" K35 W6;!print' W5	17	931
ext_8_reg.pbs	125303	-pREG '!extend bbbbbbbb;@ext-forbid "K35;! dual" K35 W6;!print' W5	18	1005
ext_9_reg.pbs	126141	-pREG '!extend bbbbbbbbb;@ext-forbid "K35 ;!dual" K35 W6;!print' W5	19	1037
ext_10_reg.pbs	126437	-pREG '!extend bbbbbbbbbb;@ext-forbid " K35;!dual" K35 W6;!print' W5	20	1051
ext_11_reg.pbs	126783	-pREG '!extend bbbbbbbbbbb;@ext-forbid " K35;!dual" K35 W6;!print' W5	21	1061
ext_12_reg.pbs	127562	-pREG '!extend bbbbbbbbbbbb;@ext-forbid " K35;!dual" K35 W6;!print' W5	22	1065
ext_13_reg.pbs	127907	-pREG '!extend bbbbbbbbbbbbb;@ext-forbid " K35;!dual" K35 W6;!print' W5	23	MACEK crashed

Forbidding $K_{3,6}$, $K_{3,6}^*$, and W_6				
Script	Sequoia Job	Command	Matroid Size	Number of Matroids Produced
ext_1_reg.pbs	124881	-pREG '!extend b;@ext-forbid "K36;!dual" K36 W6;!print' W5	11	4
ext_2_reg.pbs	124882	-pREG '!extend bb;@ext-forbid "K36;!dual" K36 W6;!print' W5	12	29
ext_3_reg.pbs	124883	-pREG '!extend bbb;@ext-forbid "K36;!dual" K36 W6;!print' W5	13	99
ext_4_reg.pbs	124884	-pREG '!extend bbbb;@ext-forbid "K36;!dual" K36 W6;!print' W5	14	265
ext_5_reg.pbs	124885	-pREG '!extend bbbbb;@ext-forbid "K36;!dual" " K36 W6;!print' W5	15	539
ext_6_reg.pbs	124886	-pREG '!extend bbbbbb;@ext-forbid "K36;!dual" K36 W6;!print' W5	16	799
ext_7_reg.pbs	124892	-pREG '!extend bbbbbbb;@ext-forbid "K36;!dual" K36 W6;!print' W5	17	987
ext_8_reg.pbs	125305	-pREG '!extend bbbbbbbb;@ext-forbid "K36;!dual" K36 W6;!print' W5	18	1155
ext_9_reg.pbs	126144	-pREG '!extend bbbbbbbbb;@ext-forbid "K36;!dual" K36 W6;!print' W5	19	1315
ext_10_reg.pbs	126438	-pREG '!extend bbbbbbbbbb;@ext-forbid "K36;!dual" K36 W6;!print' W5	20	1471
ext_11_reg.pbs	126783	-pREG '!extend bbbbbbbbbb;@ext-forbid "K36;!dual" K36 W6;!print' W5	21	MACEK crashed

Appendix F: Results From Regular Extensions of W_6

Results From Regular Extensions of W_6

Forbidding $K_{3,4}$, $K_{3,4}^*$, and W_7				
Script	Sequoia Job	Command	Matroid Size	Number of Matroids Produced
ext_1_reg.pbs	125312	-pREG '!extend b;@ext-forbid "K34;!dual" K34 W7;!print' W6	13	12
ext_2_reg.pbs	125313	-pREG '!extend bb;@ext-forbid "K34;!dual" K34 W7;!print' W6	14	99
ext_3_reg.pbs	125314	-pREG '!extend bbb;@ext-forbid "K34;!dual" K34 W7;!print' W6	15	655
ext_4_reg.pbs	125323	-pREG '!extend bbbb;@ext-forbid "K34;!dual" K34 W7;!print' W6	16	2999
ext_5_reg.pbs	126145	-pREG '!extend bbbbb;@ext-forbid "K34;!dual" " K34 W7;!print' W6	17	10399
ext_6_reg.pbs	126784	-pREG '!extend bbbbbb;@ext-forbid "K34;!dual" K34 W7;!print' W6	18	MACEK crashed
Forbidding $K_{3,5}$, $K_{3,5}^*$, and W_7				
Script	Sequoia Job	Command	Matroid Size	Number of Matroids Produced
ext_1_reg.pbs	125349	-pREG '!extend b;@ext-forbid "K35;!dual" K35 W7;!print' W6	13	12
ext_2_reg.pbs	125351	-pREG '!extend bb;@ext-forbid "K35;!dual" K35 W7;!print' W6	14	103
ext_3_reg.pbs	125352	-pREG '!extend bbb;@ext-forbid "K35;!dual" K35 W7;!print' W6	15	719
ext_4_reg.pbs	125355	-pREG '!extend bbbb;@ext-forbid "K35;!dual" K35 W7;!print' W6	16	3491
ext_5_reg.pbs	126146	-pREG '!extend bbbbb;@ext-forbid "K35;!dual" " K35 W7;!print' W6	17	12847
ext_6_reg.pbs	126785	-pREG '!extend bbbbbb;@ext-forbid "K35;!dual" K35 W7;!print' W6	18	MACEK crashed

Forbidding $K_{3,6}$, $K_{3,6}^*$, and W_7				
Script	Sequoia Job	Command	Matroid Size	Number of Matroids Produced
ext_1_reg.pbs	126788	-pREG '!extend b;@ext-forbid "K36;!dual" K36 W7;!print' W6	13	12
ext_2_reg.pbs	126789	-pREG '!extend bb;@ext-forbid "K36;!dual" K36 W7;!print' W6	14	103
ext_3_reg.pbs	126792	-pREG '!extend bbb;@ext-forbid "K36;!dual" K36 W7;!print' W6	15	719
ext_4_reg.pbs	126798	-pREG '!extend bbbb;@ext-forbid "K36;!dual" K36 W7;!print' W6	16	3507
ext_5_reg.pbs	126818	-pREG '!extend bbbbb;@ext-forbid "K36;!dual" " K36 W7;!print' W6	17	13109
ext_6_reg.pbs	127573	-pREG '!extend bbbbbb;@ext-forbid "K36;!dual" K36 W7;!print' W6	18	MACEK crashed

Appendix G: MACEK Commands and Examples

MACEK Commands and Examples

The computer program MACEK [9] has been mentioned often throughout this thesis. In this section, some background information as well as some sample commands and output used in this thesis will be provided. The MACEK program was developed by Petr Hliněný in 2001 to assist in the research of Matroid Theory. Since that time, many upgrades have been made to make this software a powerful computational tool. The program allows the user to test for minors and isomorphisms, as well as to extend and coextend matroids while avoiding certain minors. For a complete guide to MACEK, see [9].

MACEK can be used to view matroids over different fields. For example, a binary and a regular representation of $M(W_3)$ can be found by including the command "-pGF2" or "-pREG". When no field is specified, MACEK defaults to the finite field over two elements, GF(2). Note that throughout this section, some of the non-essential output will be omitted to save space. The output given next shows a matrix representation of $M(W_3)$ over GF(2).

```
./macek -pGF2 print W3
vv=====vv
~162~ Output of the command "!print (S) [1]":

~162~ Matrix of the frame 0x204620 [W3] in GF(2): "the matroid W_3, wheel of 3 spokes"
~ -----
~ matrix 0x204b70 [W3], r=3, c=3, tr=0, ref=0x0
~ '-1') '-2') '-3')
~
~ '1') 1 o 1
~ '2') 1 1 o
~ '3') o 1 1
~ -----
~=====^^
```

The following output shows a regular representation of $M(W_3)$.

```
./macek -pREG print W3
vv=====vv
~258~ Output of the command "!print (S) [1]":
~258~ Matrix of the frame 0x2025a0 [W3] in regular: "the matroid W_3, wheel of 3 spokes"
~ -----
~ matrix 0x200ea0 [W3], r=3, c=3, tr=0, ref=0x0
~ '-1') '-2') '-3')
~
~ '1') 1 o -1
~ '2') -1 1 o
~ '3') o -1 1
~ -----
~^=====^^
```

The capability of MACEK to check for minors is displayed next. Multiple matroids can be tested for a specific minor using the "minor" command. The next example shows that $M(F_7)$ is a minor of S_5 but not a minor of W_5 .

```
./macek minor S5 W5 F7
~ matrix 0x200d30 [S5], r=5, c=5, tr=0, ref=0x0
~ '-1') '-2') '-3') '-4') '-5')
~ '1') o 1 1 1 1
~ '2') 1 o 1 1 1
~ '3') 1 1 o 1 1
~ '4') 1 1 1 o 1
~ '5') 1 1 1 1 o
~ matrix 0x200d30 [W5], r=5, c=5, tr=0, ref=0x0
~ '-1') '-2') '-3') '-4') '-5')
~ '1') 1 o o o 1
~ '2') 1 1 o o o
~ '3') o 1 1 o o
~ '4') o o 1 1 o
~ '5') o o o 1 1
~ matrix 0x209c60 [F7], r=3, c=4, tr=0, ref=0x0
~ '-1') '-2') '-3') '-4')
~ '1') 1 1 1 o
~ '2') 1 1 o 1
~ '3') 1 o 1 1
~Output of the command "!minor ((-1T)) ((-1)(T)) [2]":
~The #1 matroid [S5] +HAS+ minor #1 [F7] in the list {F7 }.
~The #2 matroid [W5] has -NO- minor #0 [] in the list {F7 }.
```

The capability of MACEK [9] to extend and coextend matroids while avoiding certain minors was instrumental in this dissertation. This function of MACEK enabled us to find all of the internally 3-connected graphic $K_{3,4}$ - and W_5 -free matroids. By hand, this is a challenging computation. With MACEK, we were able to determine all of these matroids. An example of the command used to extend and coextend W_4 while avoiding $K_{3,3}^*$ and K_5^* in order to insure a graphic result, as well as $K_{3,4}$ and W_5 , is given below. Note that the command "!"extend b" means to extend and coextend in one command. We use "!"extend r" and "!"extend c" to add rows and columns, respectively.

```
./macek -pREG '!extend bb;@ext-forbid "grK33;!dual" "grK5;!dual" K34 W5;!print' W4
~ '-1') '-2') '-3') '-4')
~ '1') 1 0 0 -1
~ '2') -1 1 0 0
~ '3') 0 -1 1 0
~ '4') 0 0 -1 1
~ '5') 0 1 0 -1
~ matrix 0x208000 [W4_r2], r=5, c=4, tr=0, ref=0x0
~ '-1') '-2') '-3') '-4')
~ '1') 1 0 0 -1
~ '2') -1 1 0 0
~ '3') 0 -1 1 0
~ '4') 0 0 -1 1
~ '5') 1 -1 1 -1
~ matrix 0x208000 [W4_c1], r=4, c=5, tr=0, ref=0x0
~ '-1') '-2') '-3') '-4') '-5')
~ '1') 1 0 0 -1 0
~ '2') -1 1 0 0 1
~ '3') 0 -1 1 0 0
~ '4') 0 0 -1 1 -1
~ matrix 0x208000 [W4_r1_c1], r=5, c=5, tr=0, ref=0x0
~ '-1') '-2') '-3') '-4') '-5')
~ '1') 1 0 0 -1 0
~ '2') -1 1 0 0 0
~ '3') 0 -1 1 0 0
~ '4') 0 0 -1 1 1
~ '5') 0 1 0 -1 -1
~ matrix 0x208000 [W4_r2_c1], r=5, c=5, tr=0, ref=0x0
~ '-1') '-2') '-3') '-4') '-5')
```

```

~ '1') 1 0 0 -1 0
~ '2') -1 1 0 0 0
~ '3') 0 -1 1 0 0
~ '4') 0 0 -1 1 1
~ '5') 1 -1 1 -1 -1
~ matrix 0x208000 [W4_c1_c1], r=4, c=6, tr=0, ref=0x0
~ '-1') '-2') '-3') '-4') '-5') '-6')
~ '1') 1 0 0 -1 0 1
~ '2') -1 1 0 0 1 0
~ '3') 0 -1 1 0 0 -1
~ '4') 0 0 -1 1 -1 0

```

MACEK 1.2.12 finished OK

As shown in the examples provided, MACEK is a powerful tool for researchers in the field of Matroid Theory. A complete guide to MACEK as well as instructions on how to download this program can be found in [9].

Vita

The author, Dixie Smith (Smitty) Horne, was born in Jacksonville, Florida, to Joseph Frederick and Dixie Smith Horne. Smitty received a Bachelor of Arts degree in History and Political Science from the University of North Carolina at Chapel Hill. She is currently employed as a Systems Analyst by the School of Education at the University of Mississippi where she is responsible for the design and implementation of an automated system for collection of assessment data used for accreditation. Smitty is a candidate for the Master of Arts in Mathematics at the University of Mississippi.