

University of Mississippi

eGrove

Electronic Theses and Dissertations

Graduate School

1-1-2010

Bicircular Matroids with Circuits of at Most Two Sizes

Torina Deachune Lewis

University of Mississippi

Follow this and additional works at: <https://egrove.olemiss.edu/etd>



Part of the [Mathematics Commons](#)

Recommended Citation

Lewis, Torina Deachune, "Bicircular Matroids with Circuits of at Most Two Sizes" (2010). *Electronic Theses and Dissertations*. 1437.

<https://egrove.olemiss.edu/etd/1437>

This Dissertation is brought to you for free and open access by the Graduate School at eGrove. It has been accepted for inclusion in Electronic Theses and Dissertations by an authorized administrator of eGrove. For more information, please contact egrove@olemiss.edu.

To The Graduate Council:

I am submitting herewith a dissertation written by Torina Deachune Lewis entitled *Bicircular Matroids with Circuits of at Most Two Sizes* I have examined the final copy of this thesis for form and content and recommend that it be accepted in partial fulfillment of the requirements for the degree of Doctor of Philosophy in Mathematics.

Dr. Talmage James Reid

Professor of Mathematics

We have read this dissertation
and recommend its acceptance:

Dr. Iwo Labuda, Chair and Professor of Mathematics

Dr. Laura Sheppardson, Associate Professor of Mathematics

Dr. Dawn Wilkins, Associate Professor of Computer and Information Science

Dr. Haidong Wu, Associate Professor of Mathematics

Bicircular Matroids with Circuits of
at Most Two Sizes

A Dissertation

Presented for the

Doctor of Philosophy Degree

Department of Mathematics

University of Mississippi

Torina Deachune Lewis

Advisers: Drs. Talmage James Reid and Laura Sheppardson

December 3, 2010

Acknowledgments

The writing of a dissertation can be a lonely and isolating experience, yet it is obviously not possible without the personal and practical support of numerous people. So, first and foremost, I want to give thanks to God, my deceased mother Carolyn Lewis and my father Melvin Lewis who guided me to be the person that I am today.

Now, I would like to acknowledge my family and friends for their support. I am convinced that without their love, caring and "motivational speeches," I would not have maintained the focus, drive and determination to complete this program. You all have been a source of strength when I needed it most. To my brothers and sister, Dermell, Tiesha, Torrey, and Melvin each one of you are so diverse in how you approach life and I have borrowed some traits from each of you. I assimilated these traits to create in me an expectation for success that I will carry with me for the rest of my life.

There were so many that were instrumental to my academic success. Chief among them is Dr. Omojola, Dean of Math and Science at Southern University at New Orleans. Initially, it was notes on every quiz and test that declared "You should be a math major" that aided me in determining math as an academic and professional path. Later, it was his confidence in my talents that were on display as he introduced me to personnel at Southern University and Agricultural and Mechanical College and The University of Mississippi.

At Southern University and Agricultural and Mechanical College there was Dr. Couvillon. His constant pressing made me realize that if I wanted to continue along

this path, I must make sacrifices. Sometimes the sacrifices called for limited communication to those who were dear to me. The end result was that I achieved above my expectation. Through him, I learned this lesson of sacrifice for a goal early into this process. Dr. Couvillon, I thank you.

Now to the namesake of my Doctorate Degree, The University of Mississippi, this has been a place of discovery for me. It was here that I gained a greater level of independence. Up until placing my candidacy with the University, I had never been away from family and friends for more than a month. I have matured considerably both as an adult and academically. It was here that I learned patience gathered from the classroom and having it imparted on me from the faculty. I am extremely appreciative of the entire faculty for their willingness to assist me as a graduate instructor and a student. The lessons you have taught me are invaluable and I am sure I will carry them for the rest of my life.

I would like to acknowledge Dr. Reid, Dr. Sheppardson, and my committee members in particular. Dr. Reid's inquisitive style released in me a natural curiosity toward Matroid Theory. He always knew the right questions to present to me at the right time so I could develop and defend my dissertation. To Dr. Sheppardson, you have been a source of knowledge that I am sure I could not do without. Your unpretentious advice was invaluable and your demeanor ingratiated me toward you. I consider myself fortunate to have been embraced and guided by both Dr. Reid and Dr. Sheppardson their inspiration helped me overcome sometime seemingly difficult obstacles of being a graduate student. Honorary thanks are rendered my committee

members, Dr. Iwo Labuda, Dr. Dawn Wilkins, and Dr. Haidong Wu for their flexibility, patience, time, and expertise to better my work.

I also extend a special thanks to Mrs. Reid for without her dedication and understanding this day will not have been possible. I want to acknowledge Brittney Jackson, Dionne Bailey, Charlene, Chad, Mrs. Udella, Jerry, Tammy Lewis, Dr. Craddock, Dr Chism, and Dr. Song for their attendance at my dissertation defense, shoulder to cry on, or support throughout my stay at The University of Mississippi. To reiterate, my experience as a graduate student would not have been the same without the social and academic challenges provided by all students, faculty, and staff members of The University of Mississippi Mathematics Department. Again, to all I thank you.

Abstract

Young [19] reports that Murty [11] was the first to study matroids with all hyperplanes having the same size. Murty called such a matroid an “Equicardinal Matroid”. Young renamed such a matroid a “Matroid Design”. Further work on determining properties of these matroids was done by Edmonds, Murty, and Young [12, 20, 21]. These authors were able to connect the problem of determining the matroid designs with specified parameters with results on balanced incomplete block designs. The dual of a matroid design is one in which all circuits have the same size. Murty [12] restricted his attention to binary matroids and was able to characterize all connected binary matroids having circuits of a single size. Lemos, Reid, and Wu [8] provided partial information on the class of connected binary matroids having circuits of two different sizes. They also showed that there are many such matroids. In general, there are not many results that specify the matroids with circuits of just a few different sizes. Cordovil, Junior, and Lemos [2, 9] provided such results on matroids with small circumference. Here we determine the connected bicircular matroids with all circuits having the same size. We also provide structural information on the connected bicircular matroids with circuits of two different sizes. The bicircular matroids considered are in general non-binary. Hence these results are a start on extending Murty’s characterization of binary matroid designs to non-binary matroids.

Contents

List of Figures	vii
Chapter 1. Introduction	1
1. Matroid Concepts	2
2. Classes of Matroids	5
3. Matroid Connectivity	9
Chapter 2. Matroids with Few Circuit Sizes	10
1. Binary Matroid Designs	10
2. Matroids with Circuit-Spectrums of Small Cardinality	11
Chapter 3. Bicircular Matroids	15
1. Bicircular Matroid Concepts	15
Chapter 4. Thesis Results	20
1. Bicircular Matroid Designs	20
2. Bicircular Matroids with Circuits of Two Sizes	30
Bibliography	52
Vita	

List of Figures

1.1	A projective geometry and an affine geometry	6
1.2	Some graphs without vertex-disjoint cycles	7
2.1	A series-connection of two graphs	12
2.2	The matroid $B(r, 2)$	13
3.1	Types of bicycles	15
3.2	Some bicircular matroids	17
3.3	Some balloons	18
3.4	Rolling and replacement	19
4.1	A bundle of balloons	24
4.2	A subgraph that intersects B at precisely one vertex	26
4.3	A single t-block with precisely three arms	28
4.4	The prism graph P_6	30
4.5	A couple of 2-edge colorings of the prism	31
4.6	An alternating four-cycle	33
4.7	A 2-edge coloring of K_5	35

4.8	Adding paths to a subdivision of W_4	41
4.9	A bicycle graph associated with $K_{3,3}$	41
4.10	The prism graph Q	42
4.11	Two vertex-disjoint cycles	44
4.12	The graph K	46
4.13	Three subgraphs of K	46
4.14	Bicycles of size $3 \cdot 6$ and $3 \cdot 7$, $k = 3$	48

CHAPTER 1

Introduction

This dissertation continues a research program started in 1969 by U.S.R. Murty [11]. He was the first to investigate matroids in which the hyperplanes all have the same size. These matroids were first called *equicardinal* matroids by Murty but were later called *matroid designs* by Young [19]. Edmonds, Murty, and Young [12, 20, 21] viewed such matroids in terms of their relationships to balanced incomplete block designs. The dual of a matroid with all hyperplanes having the same size is a matroid with all circuits having the same size. We call such a matroid a *dual matroid design*. In 1971 Murty [12] characterized the connected binary matroids with all circuits having the same size. Hence Murty characterized the connected binary dual matroid designs. In 2010 Lemos, Reid, and Wu [8] characterized the connected binary matroids with circuits of two different sizes, where the largest circuit size is odd. The circuit-spectrum of a matroid M , denoted by $\text{spec}(M)$, is the set of circuit sizes of the matroid. Hence the above results are concerned with matroids with a circuit-spectrum of size at most two. Other results determining the matroids with circuit-spectrum set of small cardinality were given by Maia [9], who constructed all matroids M with $\text{spec}(M) \subseteq \{1, 2, 3, 4, 5\}$ and by Cordovil, Lemos, and Maia [2], who constructed all 3-connected binary matroids M with $\text{spec}(M) \subseteq \{3, 4, 5, 6, 7\}$. It is natural to extend the results of Murty, Lemos, Reid, and Wu to different classes of

matroids. This dissertation will focus on the class of connected bicircular matroids having at most two different circuit sizes. These matroids are for the most part non-binary, whereas the matroids considered by Murty and by Lemos, Reid, and Wu were binary.

In Chapter 1 of the dissertation we introduce the matroid concepts related to this work. In Chapter 2 of the dissertation we give results from literature on matroids with a small circuit-spectrum. In Chapter 3 of the dissertation we discuss the matroids considered here, the bicircular matroids. Finally, the results of the dissertation are given in Chapter 4.

1. Matroid Concepts

What is a matroid? This is a mathematical structure first introduced by Hassler Whitney in 1935 [18] to abstractly capture the notion of dependence that is common to many mathematical fields such as projective geometry and graph theory. Whitney's definition embraces a surprising diversity of combinatorial structures. Moreover, matroids arise naturally in combinatorial optimization since they are precisely the independence structures to which the greedy algorithm can be applied to find a maximal independent set of maximum weight. An introduction to Matroid Theory can be found in the textbook of Oxley entitled "Matroid Theory" [14]. Below is the definition of a matroid.

DEFINITION 1.1. *A matroid M is an ordered pair (E, \mathcal{I}) consisting of a finite set E and a collection \mathcal{I} of subsets of E satisfying the following three conditions:*

- (I1) $\emptyset \in \mathcal{I}$.
- (I2) If $I \in \mathcal{I}$ and $I' \subseteq I$, then $I' \in \mathcal{I}$.
- (I3) If I_1 and I_2 are in \mathcal{I} and $|I_1| < |I_2|$, then there is an element e of $I_2 - I_1$ such that $I_1 \cup e \in \mathcal{I}$.

The members of \mathcal{I} are called the *independent sets* of M and E is called the *ground set* of M . It is also common to write $\mathcal{I}(M)$ for \mathcal{I} and to write $E(M)$ for E . Any subset of E that is not *independent* is called *dependent*. A *minimal dependent set* is a dependent set with all proper subsets being independent. A matroid M can also be defined by its set of minimal dependent sets called *circuits*. The set of circuits of M is denoted by \mathcal{C} or $\mathcal{C}(M)$.

THEOREM 1.2. *A set of subsets \mathcal{C} of a non-empty finite set E is the set of circuits of a matroid if and only if \mathcal{C} satisfies the following three conditions.*

- (C1) $\emptyset \notin \mathcal{C}$.
- (C2) If C_1 and C_2 are members of \mathcal{C} and $C_1 \subseteq C_2$, then $C_1 = C_2$.
- (C3) If C_1 and C_2 are distinct members of \mathcal{C} and $e \in C_1 \cap C_2$, then there is a member C_3 of \mathcal{C} such that $C_3 \subseteq (C_1 \cup C_2) - e$. (**Circuit Elimination Axiom**)

We have introduced two fundamental types of subsets of a matroid, the independent sets and the minimal dependent sets. The maximal independent sets in a matroid also obey certain axioms. A maximal independent set of a matroid M is called a *basis* of M .

THEOREM 1.3. *Let \mathcal{B} be a set of subsets of a non-empty set E . Then \mathcal{B} is the collection of bases of a matroid on E if and only if it satisfies the following conditions.*

(B1) *\mathcal{B} is non-empty.*

(B2) *If B_1 and B_2 are members of \mathcal{B} and $x \in B_1 - B_2$, then there is an element y of $B_2 - B_1$ such that $(B_1 - x) \cup y \in \mathcal{B}$. (**Basis Exchange Axiom**)*

The members of \mathcal{B} are equicardinal. In fact, if X is any subset of the ground set of a matroid M , then the maximal independent subsets of X are equicardinal. This common cardinality is called the *rank* of X . We denote this number by $r(X)$ and let $r(M) = r(E(M))$. The following theorem characterizes precisely when certain functions can be the rank function of a matroid.

THEOREM 1.4. *Let E be a set. A function $r : 2^E \rightarrow Z^+ \cup \{0\}$ is the rank function of a matroid on E if and only if r satisfies the following conditions:*

(R1) *If $X \subseteq E$, then $0 \leq r(X) \leq |X|$.*

(R2) *If $X \subseteq Y \subseteq E$, then $r(X) \leq r(Y)$.*

(R3) *If X and Y are subsets of E , then $r(X \cup Y) + r(X \cap Y) \leq r(X) + r(Y)$.*

Let M be a matroid on E and $X \subseteq E$. Then $cl(X) = \{x \in E : r(X \cup x) = r(X)\}$. A set $X \subseteq E$ is a *flat* of M if $cl(X) = X$. A flat is sometimes called a *closed set*. A flat of M of rank $r(M) - 1$ is called a *hyperplane*.

Throughout this research we examine several classes of matroids and their structure. Thus it's imperative to understand when two matroids are the same (isomorphic). The matroids M_1 and M_2 are isomorphic, denoted by $M_1 \cong M_2$, if there is a

bijection ψ from $E(M_1)$ to $E(M_2)$ such that, for all $X \subseteq E(M_1)$, $\psi(X)$ is independent in M_2 if and only if X is independent in M_1 .

2. Classes of Matroids

In this section of the dissertation we discuss several different classes of matroids that are pertinent to this research. Two common ways to represent a matroid are by matrices and graphs. We next discuss such representations. Any matrix gives rise to a matroid as stated in the following well-known result (see Proposition 1.1.1 of [14]).

PROPOSITION 1.5. *Let E be the set of column labels of an m by n matrix A over a field F , and let \mathcal{I} be the set of subsets X of E for which the multiset of columns labeled by X is linearly independent in the vector space $V(m, F)$ for some positive integers m and n . Then \mathcal{I} satisfies axioms (I1), (I2), and (I3) so that (E, \mathcal{I}) is a matroid.*

The matroid M above is called the *vector matroid* of the matrix A . If M is the vector matroid of a matrix A over some field F , then M is said to be *representable over F* or *F -representable*. A *binary matroid* is a matroid that is representable over $GF(2)$. Murty [12], and later Lemos, Reid, and Wu [8], studied the class of binary matroids with a circuit-spectrum of small cardinality. The binary projective geometry of rank r over $GF(2)$ is denoted by $PG(r - 1, 2)$ for each positive integer r . This is the vector matroid of the matrix over $GF(2)$ consisting of all nonzero column vectors of $V(r, 2)$. The matrix for which $PG(2, 2)$ is the vector matroid is given in Figure 1.1. The binary affine geometry of rank r over $GF(2)$ is denoted by $AG(r - 1, 2)$ for each

positive integer r . This matroid is obtained by deleting a hyperplane of $PG(r - 1, 2)$. For example, one can delete all columns that contain a zero in a particular row of matrix representation for $PG(r - 1, 2)$ to obtain a representation for $AG(r - 1, 2)$. In Figure 1.1 we have deleted all columns with a zero in the first entry from the matrix representing $PG(3, 2)$ to obtain a matrix representation for $AG(3, 2)$.

$$\begin{array}{c}
 \begin{array}{ccccccc}
 1 & 2 & 3 & 4 & 5 & 6 & 7 \\
 \left(\begin{array}{ccccccc}
 1 & 0 & 0 & 0 & 1 & 1 & 1 \\
 0 & 1 & 0 & 1 & 0 & 1 & 1 \\
 0 & 0 & 1 & 1 & 1 & 0 & 1
 \end{array} \right) \\
 \text{(a) } PG(2, 2)
 \end{array}
 &
 \begin{array}{c}
 \begin{array}{cccccccc}
 1 & 2 & 3 & 4 & 5 & 6 & 7 & 8 \\
 \left(\begin{array}{cccccccc}
 1 & 1 & 1 & 1 & 1 & 1 & 1 & 1 \\
 0 & 1 & 0 & 0 & 0 & 1 & 1 & 1 \\
 0 & 0 & 1 & 0 & 1 & 0 & 1 & 1 \\
 0 & 0 & 0 & 1 & 1 & 1 & 0 & 0
 \end{array} \right) \\
 \text{(b) } AG(3, 2)
 \end{array}
 \end{array}
 \end{array}$$

FIGURE 1.1. A projective geometry and an affine geometry

The graph theory terminology used here mostly follows West [17]. Pictures of the wheel graph W_r with r -spokes ($r \geq 3$), the complete graph on five vertices K_5 , and the complete bipartite graph $K_{3,p}$ ($p \geq 3$) are given in Figure 1.2. We have labeled the edges of W_r by A_i and B_i for $i \in \{1, 2, \dots, r\}$. The edges A_i are called the *spokes* of W_r and the edges B_i are called the *rim* of W_r . For an positive integer k , a k -subdivision of a graph is obtained by replacing each edge by a path of length k . A 3-subdivision of the graph W_5 is also given in Figure 1.2. Any finite graph yields a matroid as stated in the following well-known result (see Proposition 1.1.7 of [14]).

PROPOSITION 1.6. *Let E be the set of edges of a graph G and \mathcal{C} be the set of edge sets of cycles of G . Then \mathcal{C} is the set of circuits of a matroid on E .*

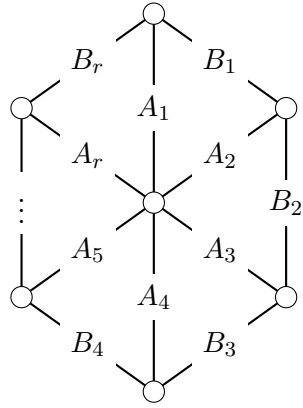

(a) The graph W_r

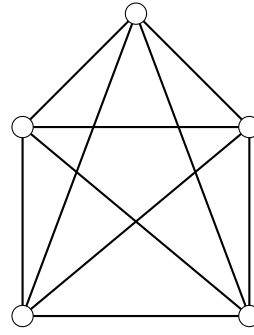

(b) The graph K_5

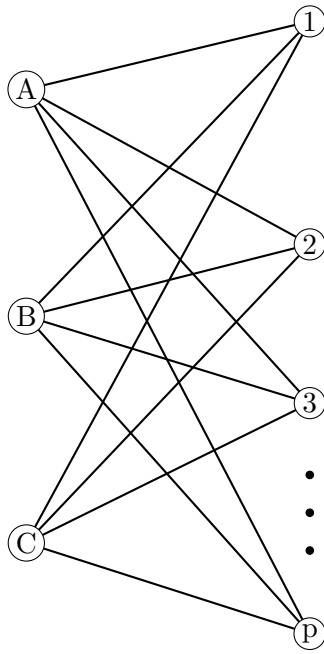

(c) The graph $K_{3,p}$

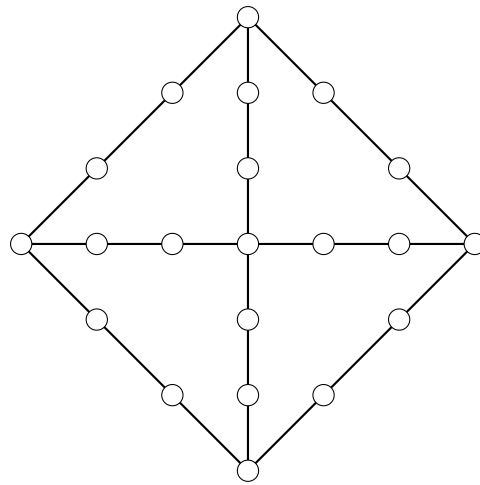

(d) A 3-subdivision of W_4

FIGURE 1.2. Some graphs without vertex-disjoint cycles

The matroid derived from G above is called the *cycle matroid* of G and is denoted by $M(G)$. A *graphic matroid* is a matroid that is the cycle matroid of some graph. The set of independent sets \mathcal{I} of $M(G)$ has as its members edge sets of G that are acyclic. One can show that a graphic matroid is representable over every field (see, for example, [14, Section 5.1]).

Let r and n be non-negative integers such that $r \leq n$. Let E be an n -element set and \mathcal{B} be the collection of r -element subsets of E . One can check that \mathcal{B} is the set of bases of a matroid on E . We denote this matroid by $U_{r,n}$ and call it the *uniform matroid* of rank r on an n -element set.

Let M be a matroid on E . Then the *dual matroid* of M is the matroid on E with bases $\{E - B : B \in \mathcal{B}(M)\}$. This dual matroid of M is denoted by M^* . Hence $U_{r,n}^* \cong U_{n-r,n}$ for nonnegative integers r and n with $0 \leq r \leq n$ and $n > 0$.

Let S be a finite set. Let $\mathcal{A} = (A_1, A_2, \dots, A_m) = (A_j : j \in J)$, with $J = \{1, 2, \dots, m\}$, be a family of subsets of S . A *system of distinct representatives* or a *transversal* of \mathcal{A} is a subset $\{e_1, e_2, \dots, e_m\}$ of S such that $e_i \in A_i$ for each $i \in J$. If $X \subseteq S$, then X is a *partial transversal* of $(A_j : j \in J)$ if for some subset K of J , X is a transversal of $(A_j : j \in K)$. The *transversal matroid* $M[\mathcal{A}]$ is the matroid with ground set S and independent sets being the partial transversals of \mathcal{A} . This class of matroids is especially important because bicircular matroids are transversal matroids as shown by Matthews [10].

3. Matroid Connectivity

Let k be a positive integer. Then, for a matroid M , a partition (X, Y) of $E(M)$ is a k -separation if

$$\min\{|X|, |Y|\} \geq k$$

and

$$r(X) + r(Y) - r(M) \leq k - 1.$$

Next let $\tau(M) = \min\{j : M \text{ has a } j\text{-separation}\}$ if M has a j -separation for some $j \in \{2, 3, \dots\}$, otherwise, let $\tau(M) = \infty$. For an integer $n \geq 2$, a matroid M is n -connected if and only if $\tau(M) \geq n$. The parameter $\tau(M)$ is called the *Tutte-connectivity* of M . If n is an integer exceeding one, then we say that M is n -connected if $\tau(M) \geq n$. Connectivity is invariant over duality since, for a partition (X, Y) of $E(M)$, it can be shown that $r(X) + r(Y) - r(M) = r(X) + r^*(X) - |X| = r^*(X) + r^*(Y) - r^*(M)$. So (X, Y) is a k -separation of M if and only if it is a k -separation of M^* and $\tau(M) = \tau(M^*)$. We are particularly interested in 2-connected matroids in this dissertation. A 2-connected matroid is often said to be *connected*. One can show that a matroid is connected if and only if each pair of distinct elements is contained in some circuit of the matroid [16].

CHAPTER 2

Matroids with Few Circuit Sizes

We discuss the results from the literature that motivate this dissertation in this chapter.

1. Binary Matroid Designs

The first characterization of a class of matroids with circuits of only one size was given by Murty [12]. Some terminology is given next before the statement of Murty's result. Recall that the *circuit-spectrum* of a matroid is the set whose members are the cardinalities of its circuits. A *series class* of a matroid is a maximal subset of the ground set such that each pair of distinct elements of the subset are a cocircuit of the matroid. A *k-subdivision* of a matroid is obtained by replacing each element by a series class of size k . This notion generalizes such subdivisions from graphs to matroids.

THEOREM 2.1. [12] *Let M be a connected binary matroid. For $\eta \in \mathbb{Z}^+$, $\text{spec}(M) = \{\eta\}$ if and only if M is isomorphic to one of the following matroids:*

- (i) *an η -subdivision of $U_{0,1}$,*
- (ii) *a k -subdivision of $U_{1,n}$, where $\eta = 2k$ and $n \geq 3$,*
- (iii) *an l -subdivision of $PG(r, 2)^*$, where $\eta = 2^r l$ and $r \geq 2$,*
- (iv) *an l -subdivision of $AG(r + 1, 2)^*$, where $\eta = 2^r l$ and $r \geq 2$.*

The previous result specifies the connected binary matroids whose dual matroids are matroid designs. Extensions of this result are given in the next section of the dissertation.

2. Matroids with Circuit-Spectrums of Small Cardinality

In this section of the dissertation we present results on matroids with a circuit-spectrum of small cardinality exceeding one. Before presenting such results of Lemos, Reid, and Wu [8] we introduce some particular matroids as well as give some terminology.

If M is a matroid, then the sets of circuits, hyperplanes, and series classes of M are denoted by $\mathcal{C}(M)$, $\mathcal{H}(M)$, and $\mathcal{S}(M)$, respectively. The *series-connection* of matroids M and N is denoted by $S(M, N)$ [14, Section 7.1]. A series-connection $S(G, H)$ of two graphs G and H is given Figure 2.1. The cycles of G and H determine the cycles of $S(G, H)$. In a similar manner, the circuits of the matroids M_1 and M_2 determine the circuits of $S(M_1, M_2)$. Let \mathcal{C}_1 and \mathcal{C}_2 denote the sets of circuits of M_1 and M_2 , respectively, and \mathcal{C}_S be the set of circuits of $S(M_1, M_2)$. If the ground set of M_i contains an element p_i , which is neither a loop nor a coloop ($i = 1, 2$), then the series connection of M_1 and M_2 across the elements p_1 and p_2 is given by

$$\mathcal{C}_S = \mathcal{C}(M_1 \setminus p_1) \cup \mathcal{C}(M_2 \setminus p_2) \cup \{(C_1 - p_1) \cup (C_2 - p_2) \cup p : p_i \in C_i \in \mathcal{C}(M_i), i = 1, 2\}$$

where p is a new element that is in neither the ground set of M_1 nor in the ground set of M_2 .

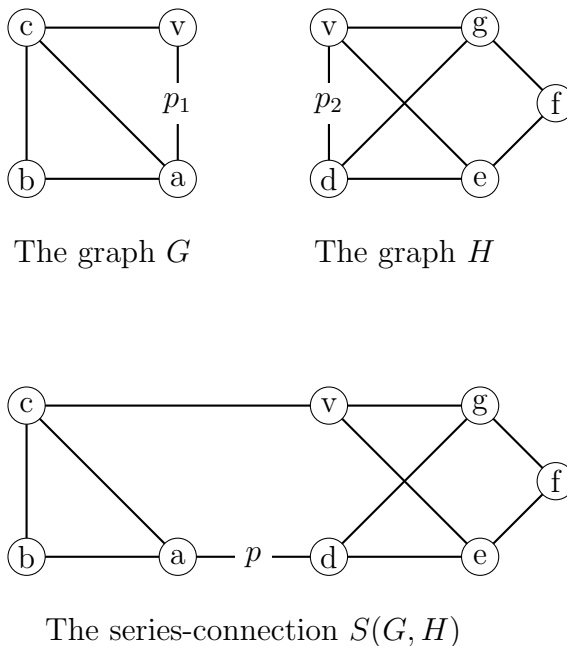

FIGURE 2.1. A series-connection of two graphs

For an integer exceeding two, the binary spike of rank n , denoted by S_n , is the vector matroid of the matrix consisting of all binary columns of length n with exactly one, $n - 1$, or n ones. The *tip* (*cotip*) of S_n (S_n^*) corresponds to the column of all ones. The Fano-matroid is S_3 .

The matroid $B(r, 2)$ is constructed as follows. Add a point e of projective space to $AG(r, 2)$, where e is outside the $r + 1$ -dimensional subspace determined by $AG(r, 2)$. Add a point of projective space to each line joining e to a point of $AG(r, 2)$. The resulting matroid is $B(r, 2)$ (see Figure 2.2). Equivalently, $B(r, 2)$ may be constructed by adding a single new point e of $PG(r+1, 2)$ to $AG(r+1, 2)$. The element e mentioned above is called the *tip* (*cotip*) of $B(r, 2)$ and $B(r, 2)^*$ respectively.

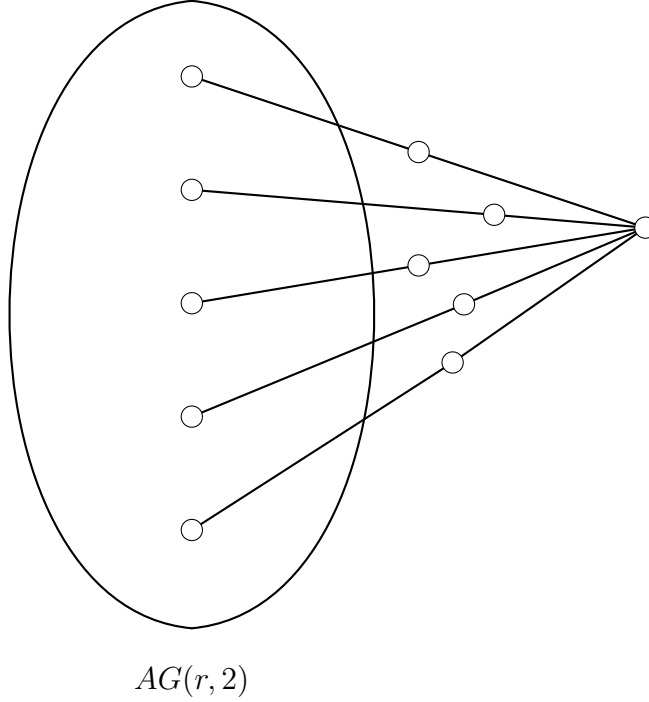

FIGURE 2.2. The matroid $B(r, 2)$

THEOREM 2.2. [8] *Let $c, d \in \mathbb{Z}^+$ with $c < d$ and d odd. Let M be a connected binary matroid. Then $\text{spec}(M) = \{c, d\}$ if and only if there are connected binary matroids M_0, M_1, \dots, M_n for some $n \in \mathbb{Z}^+$ such that the following hold.*

- (i) $E(M_i) \cap E(M_j) = \{e\}$, for distinct i and j in $\{0, 1, \dots, n\}$.
- (ii) $E(M_0)$ is a circuit of M_0 .
- (iii) For $i \in \{1, 2, \dots, n\}$, $\{e\}$ is a series class of M_i , all other series class of M_i have size l_i , and the cosimplification of M_i is isomorphic to one of the following matroids.
 - (a) U_{1, n_i} , for some $n_i \geq 3$, where $c = 2l_i$.
 - (b) $PG(r_i, 2)^*$, for some $r_i \geq 2$, where $c = 2^{r_i} l_i$.

- (c) $AG(r_i, 2)^*$, for some $r_i \geq 3$, where $c = 2^{r_i-1}l_i$.
 - (d) $S_{n_i}^*$, for some $n_i \geq 4$, and e is the cotip, where $c = 4l_i$.
 - (e) $B(r_i, 2)^*$, for some $r_i \geq 3$, and e is the cotip, where $c = 2^{r_i}l_i$.
- (iv) $d = |E(M_0)| - 1 + d_1 + d_2 + \cdots + d_n > c$, where $d_i = \frac{c}{2}$ when (iii) (a) holds, $d_i = (2^{r_i} - 1)l_i$ when (iii) (b) holds, $d_i = (2^{r_i-1} - 1)l_i$ when (iii) (c) holds, $d_i = n_i l_i$ when (iii) (d) holds, and $d_i = c$ when (iii) (e) holds.
- (v) $M = S(M_0, M_1, \dots, M_n)/e$.

Note that the complex statement of the above theorem indicates the difficulty in obtaining a complete characterization of the binary matroids with a spectrum of size two. Further, Lemos, Reid, and Wu constructed many such matroids in the paper in which this theorem appears. The above theorem simplifies greatly if one restricts their attention to 3-connected matroids as stated in the following result.

COROLLARY 2.3. *Let M be a 3-connected binary matroid with largest circuit size odd. Then $|\text{spec}(M)| \leq 2$ if and only if M is isomorphic to one of the following matroids.*

- (i) $U_{0,1}$ or $U_{2,3}$.
- (ii) S_{2n}^* , for some $n \geq 2$.
- (iii) $B(r, 2)^*$, for some $r \geq 2$.

CHAPTER 3

Bicircular Matroids

In this chapter of the dissertation we provide some background results on bicircular matroids.

1. Bicircular Matroid Concepts

This research is focused on the class of matroids called bicircular matroids. We review some definitions and some basic properties of bicircular matroids in this section

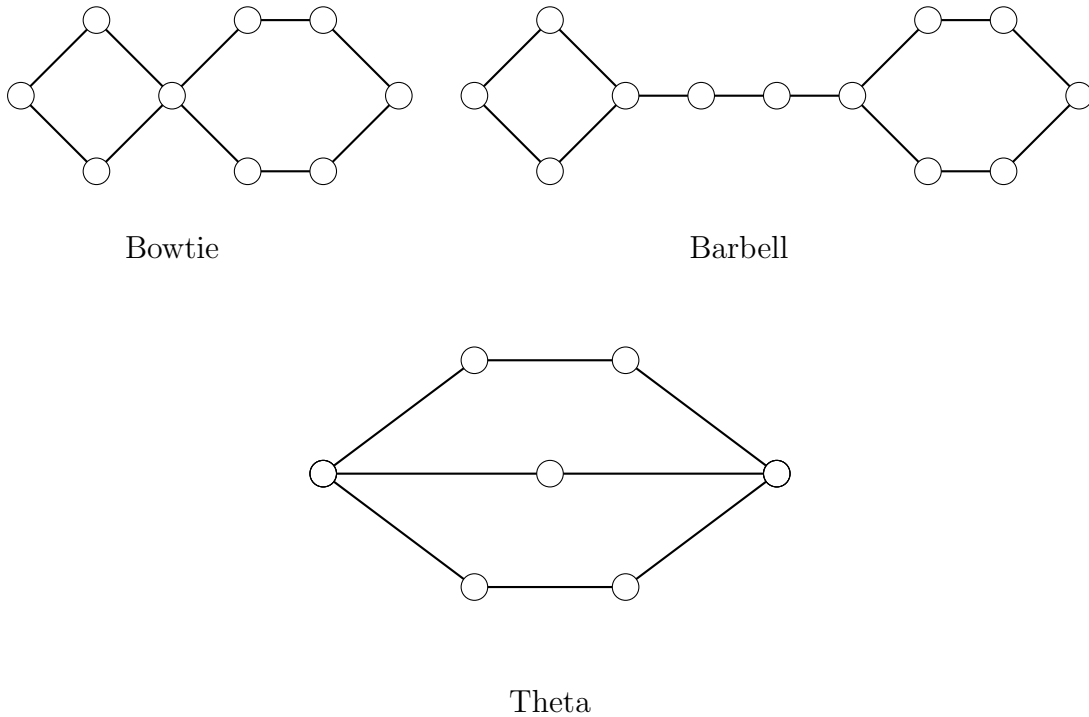

FIGURE 3.1. Types of bicycles

of the dissertation (see [3] and [13] for most of this material). Let G be a graph on edge set E . The bicircular matroid of G , denoted by $B(G)$, has ground set E and circuits being the edge sets of subdivisions of one of the following three graphs: (i) two loops that share a vertex, (ii) two loops with distinct vertices that are joined by an edge, (iii) three edges joining the same pair of vertices. The circuits of $B(G)$ are called the *bicycles* of G . A bicycle of type (i), (ii), or (iii) is referred to as a bow-tie, a barbell, or a theta, respectively (see Figure 3.1 for some examples). Moreover, if M is a bicircular matroid and G is a graph such that $M=B(G)$ then G is called a *representation of M* .

A set of edges E is *independent* in the bicircular matroid $B(G)$ provided each connected component of $G[E]$, the subgraph of G induced by the edge set E , contains at most one cycle. In a bicircular matroid, the *rank* of a set X of edges is $r(X) = n(X) - t(X)$, where $n(X)$ is the number of vertices incident with the edges of X and $t(X)$ is the number of non trivial tree components of X . The maximal independent sets of $B(G)$ have cardinality equal to n .

Each bicircular matroid is known to be a transversal matroid (see Matthews [10]). Let E_i be the set of edges of G which are incident with vertex i for $i = 1, 2, \dots, n$. Then $B(G)$ is a transversal matroid whose independent sets are the partial transversals of the family of sets $\xi(G) = (E_1, E_2, \dots, E_n)$. The family of sets $\xi(G)$ is the *natural presentation* of $B(G)$ corresponding to the graph G . The transversal matroid M has many minimal presentations (C_1, C_2, \dots, C_n) . The sets C_i in each *minimal presentation* are distinct cocircuits of M .

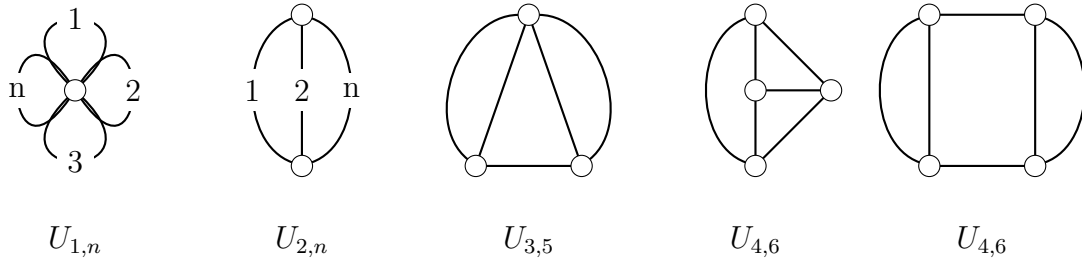

FIGURE 3.2. Some bicircular matroids

Graphs whose bicircular matroids are isomorphic to the matroids $U_{1,n}$ and $U_{2,n}$, for $n \geq 2$, $U_{3,5}$, and $U_{4,6}$ are given in Figure 3.2. Note that two last two graphs in that figure are not isomorphic but have the same bicircular matroid $U_{4,6}$. Coullard, del Greco, and Wagner [3] determined precisely when this phenomenon can occur using certain graph operations (see also [13]). After first giving some more graph terminology we will describe two of these operations.

Let G be a graph with F a non-empty proper subset of the edge set E . The *vertex-boundary* of F consists of those vertices of G that are in both of the subgraphs induced by F and induced by $E - F$. A *block* is a maximal connected subgraph without a cutvertex. An *end-block* of G is a block whose vertex-boundary contains exactly one vertex. A *balloon* of G is subgraph of G which is a subdivision one of the two graphs of Figure 3.3, whose vertex-boundary contains exactly one vertex. The vertex boundary (the vertices v and w pictured there) is called the *tip* of the balloon.

A *path* of G is a sequence $v_0 e_1 v_1 e_2 \dots v_{k-1} e_k v_k$ such that v_0, v_1, \dots, v_k are distinct vertices, e_1, e_2, \dots, e_k are distinct edges, and each vertex or edge in the sequence, except v_k , is incident with its successor in the sequence. A *line* of G is a set of edges that

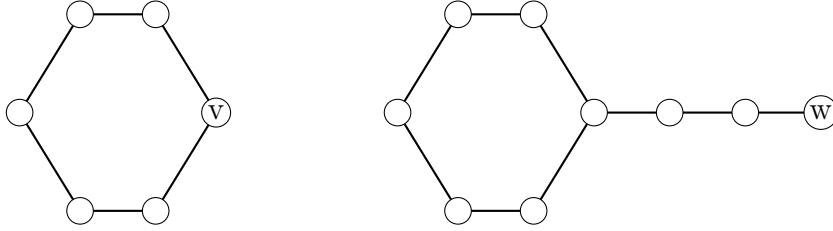

FIGURE 3.3. Some balloons

forms a path with the internal vertices having degree two and the end-vertices having degree at least three. We further require that the line is not contained in any balloon. Now let L be a line of G with endvertices u and v and e be the edge of L that is incident with v .

Let H be a graph obtained from G by redefining the incidence relation of e so that e is adjacent to a vertex $w \neq v$ of L instead of v . Then H is said to be obtained from G by *rolling* L away from v . Likewise, G is said to be obtained from H by *unrolling* of L to v . Note that L is a balloon of H (see, for example, the top left graph of Figure 3.4). Hence the operation of unrolling reduces the number of balloons of a graph. The following useful results can be found in [3] and [15].

LEMMA 3.1. *Suppose that G and H are graphs with $B(H)$ connected and H is obtained from G by rolling a line L away from a vertex v . Then $B(G) = B(H)$ if and only if v is the tip of an end-block of G that contains L and every cycle of the end-block contains v .*

LEMMA 3.2. *If H is a graph obtained from a graph G replacing a balloon with another balloon on the same edge set and with the same vertex-boundary, then $B(G) = B(H)$.*

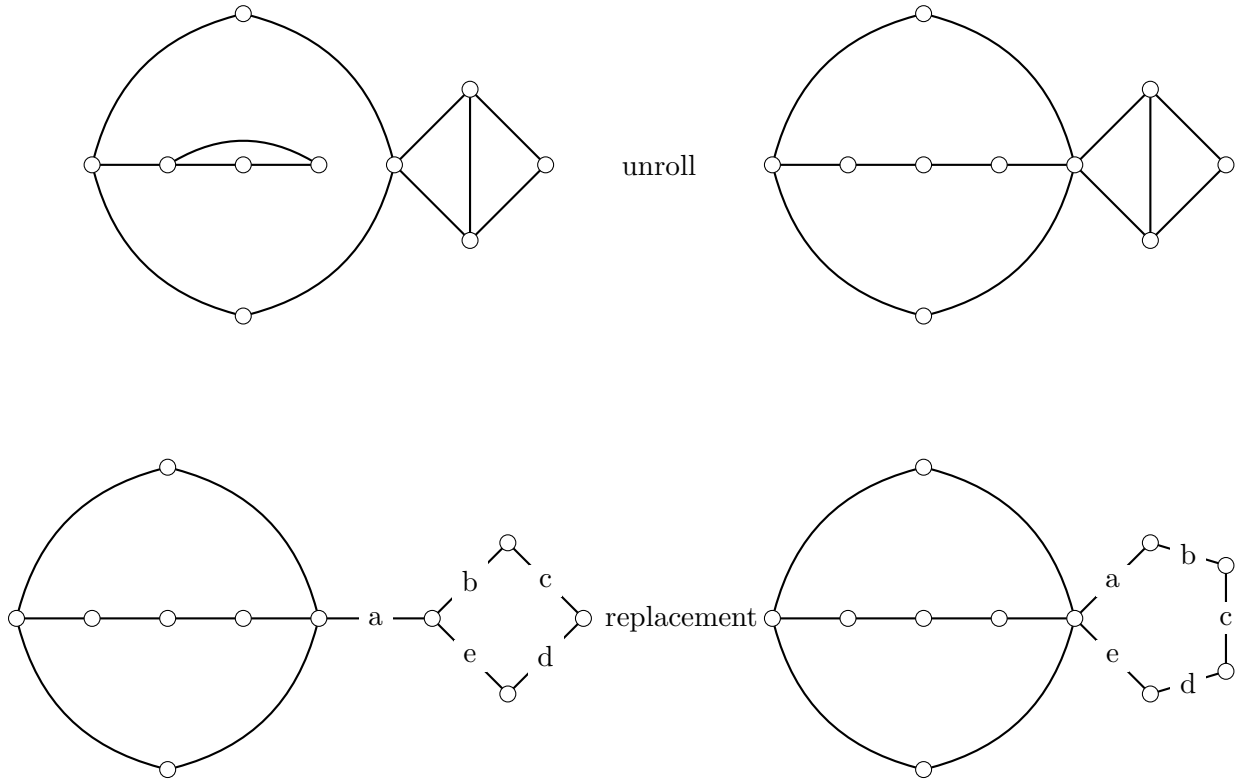

FIGURE 3.4. Rolling and replacement

As mentioned before, Coullard, del Greco, and Wagner in [3] further expand on Lemmas 3.1 and 3.2, although these are the two primary lemmas used here.

CHAPTER 4

Thesis Results

The results of the dissertation are given in this chapter. In the first section of the chapter we determine the (dual) connected bicircular matroid designs. In the second section of the chapter we extend this results to bicircular matroids with two circuit sizes in the special case that the associated graph is 3-connected.

1. Bicircular Matroid Designs

The first main result of the dissertation is given next. This matroid characterizes the matroids whose duals are connected bicircular matroid designs.

THEOREM 4.1. *Let M be a connected bicircular matroid. For $\eta \geq 2$, $\text{spec}(M) = \{\eta\}$ if and only if M is isomorphic to one of the following matroids:*

- (i) *a k -subdivision of $U_{1,n}$ where $\eta = 2k$ and $n \geq 2$,*
- (ii) *a k -subdivision of $U_{2,n}$ where $\eta = 3k$ and $n \geq 3$,*
- (iii) *a k -subdivision of $U_{3,5}$ where $\eta = 4k$, or*
- (iv) *a k -subdivision of $U_{4,6}$ where $\eta = 5k$.*

We present the proof of Theorem 4.1 in this section of the paper after first giving some graph terminology. Let G be a graph. Where X and Y are subgraphs of G , an X - Y *path* is a path which intersects each of X and Y in exactly one vertex. A

path is said to be *internally disjoint* from a subgraph X if it intersects X only in its endvertices, if at all. Each *block* of G is either a maximal 2-connected subgraph, a cut-edge (bridge), or an isolated vertex (i.e. a vertex with no incident edges). We will call a block a *t-block* if it is not a vertex, a single edge, or a cycle. Note that in any t-block, there must be some pair of vertices $\{u, v\}$ for which the block contains at least three internally disjoint u - v paths. We call any such pair a *branching pair* of the block. A set of internally disjoint u - v paths is called a set of *arms* of the block. When P is a path in a graph G , and $u, v \in V(P)$, we let $P[u, v]$ denote the subpath of P between u and v , inclusive. Let $P(u, v) := P[u, v] - \{u, v\}$, $P(u, v) := P[u, v] - u$, and $P(u, v) := P[u, v] - v$. We use similar notation to indicate subpaths in cycles. We will use the convention that an uppercase letter refers to a subgraph, while the corresponding lowercase letter refers to the number of edges in that subgraph. So where P_1 is a path, for example, p_1 is the number of edges in that path. A graph is said to be a *bundle of balloons* if its edge set can be partitioned into disjoint balloons whose vertex boundaries share a single common vertex (see, for example, the first graph of Figure 3.2).

PROOF OF THEOREM 4.1. First note that if M is isomorphic to one of the matroids listed in the theorem statement, then $\text{spec}(M) = \{\eta\}$. Conversely, let G be a graph without isolated vertices whose bicircular matroid represents M and suppose that $\text{spec}(M) = \{\eta\}$. We begin by showing that we may assume that G satisfies the following conditions.

- (1) G is connected, with minimum degree at least two, and each balloon of G is a cycle.
- (2) G includes at most one t-block.
- (3) There is a block B of G whose vertex-boundary meets all blocks of G .
- (4) If G has no t-block, then it is a bundle of balloons.

PROOF OF (1). The matroid M is connected with at least two elements so that each pair of edges of G is contained in a bicycle. Thus G is connected. Suppose that G has a vertex v of degree one. Then the unique edge of G that meets v is in no bicycle; a contradiction. Hence the minimum degree of G is at least two. It follows from Lemma 3.2 that each balloon G may be replaced by a cycle with its tip being the unique vertex in its vertex-boundary. \square

PROOF OF (2). It follows from Lemma 3.1 that we may assume that G has the fewest number of balloons among all representations for M that satisfy condition (1) (no unrolling of a balloon is possible). Suppose G includes two t-blocks B and B' . Let u, v be a branching pair of B with arms P_1, P_2 , and P_3 and let x, y be a branching pair of B' with 3 arms Q_1, Q_2 , and Q_3 . Since G is connected there is some B - B' path R . Without loss of generality, assume that R intersects paths P_1 and Q_1 . Consider the following bicycles of G .

$$P_1 \cup P_2 \cup P_3 \quad P_1 \cup P_2 \cup R \cup Q_1 \cup Q_2 \quad Q_1 \cup Q_2 \cup Q_3 \quad P_1 \cup P_3 \cup R \cup Q_1 \cup Q_3$$

From the first two bicycles we obtain $p_3 = r + q_1 + q_2$, and from the last two bicycles we obtain

$$\begin{aligned}
\eta &= p_1 + p_3 + r + q_1 + q_3 \\
&= p_1 + (r + q_1 + q_2) + r + q_1 + q_3 \\
&= q_1 + q_2 + q_3 + q_1 + p_1 + 2r \\
&= \eta + q_1 + p_1 + 2r
\end{aligned}$$

Thus $q_1 + p_1 + 2r = 0$; a contradiction. Therefore G includes at most one t-block. □

PROOF OF (3). If G contains a t-block, call it B and label some set of its arms B_1, \dots, B_n for $n \geq 3$. Otherwise, let B be any cycle of G which is not a balloon if such exists, or any balloon if it does not, and let B_1 and B_2 be any two paths forming a partition of the edges of B . We now proceed to show that every balloon of G must have its tip in B . This will show that every end-block, and hence every block, must meet the vertex boundary of B .

Suppose there is some balloon C of G whose tip v is not in B . Then there is some cycle D with the vertex-boundary of C and D meeting in v . There is a path P from D to B that is internally disjoint from C . Let $u = P \cap D$, $w = P \cap B$, and assume without loss of generality that $w \in B_1$. Note that $C \cup D$ is a bicycle, so $\eta = c + d$

When $u = v$ (Figure 4.1 (A)), we must have $p > 0$. By symmetry $c = d$, and hence $\eta = 2c$. Since $B_1 \cup B_2 \cup P \cup C$ is a bicycle, we have $b_1 + b_2 + p = c$. Alternatively,

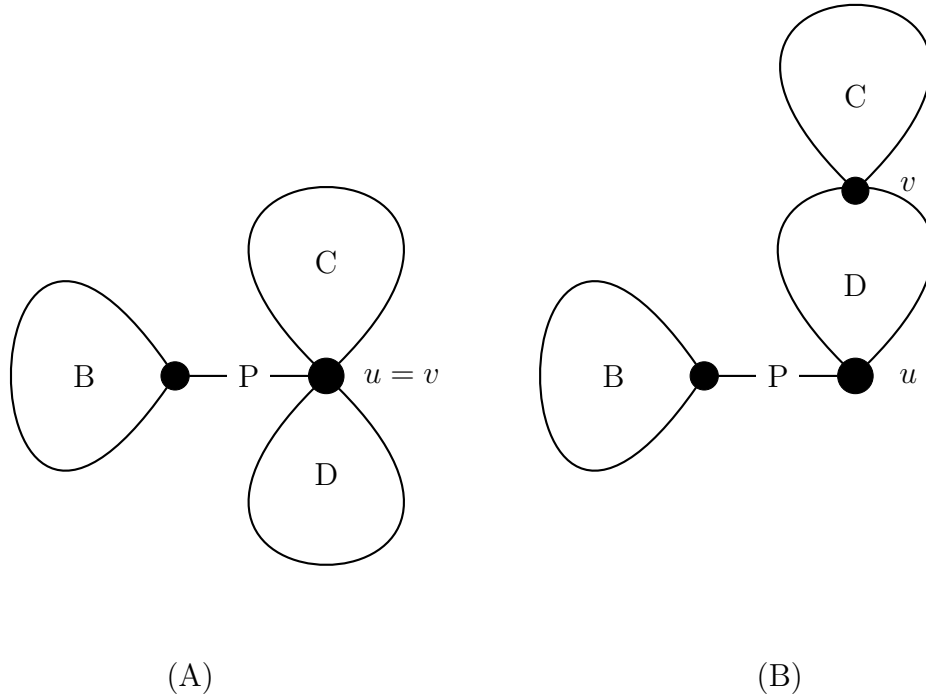

FIGURE 4.1. A bundle of balloons

when $u \neq v$ (Figure 4.1 (B)), fix an orientation of the cycle D and let $D_1 = D[u, v]$, $D_2 = D[v, u]$. Then each of the following is a bicycle.

$$B_1 \cup B_2 \cup P \cup D \quad B_1 \cup B_2 \cup P \cup D_1 \cup C \quad B_1 \cup B_2 \cup P \cup D_2 \cup C$$

So we have $d_1 = d_2$ and $d_1 + c = d$. Hence $d_1 = d_2 = c$, and $\eta = 3c$. Again we find $b_1 + b_2 + p = c$.

Consider the case that B is a t-block. Then $B_1 \cup B_2 \cup B_3$ is a bicycle, so $b_1 + b_2 + b_3 = \eta = c + d$. By symmetry, we have $b_2 = b_3$. From the arguments above we know

$b_1 + b_2 + p = c$. So

$$2c = (b_1 + b_2 + p) + (b_1 + b_3 + p) = (b_1 + b_2 + b_3) + b_1 + 2p = c + d + b_1 + 2p$$

which gives $c = d + b_1 + 2p$. But from above we have either $d = c$ (when $u = v$) or $d = 2c$ (when $u \neq v$), and hence this is impossible.

Now consider the case that B is a cycle. Suppose B intersects exactly one other block. Then B is a balloon. By our choice of B , every cycle must be a balloon, and G is a bundle of two balloons (i.e. a bowtie). We are left with the case that the cycle B intersects at least two other blocks. We may choose some subgraph A which contains exactly one cycle, is disjoint from $C \cup D \cup P$, and intersects B at exactly one vertex. (See Figure 4.2.) Then $B_1 \cup B_2 \cup A$ is a bicycle, so $b_1 + b_2 + a = \eta$. Since $b_1 + b_2 + p = c$, we have $a + c = \eta + p$. But there is some bicycle which strictly contains $A \cup C$, so $a + c < \eta$; a contradiction. \square

PROOF OF (4). Here G has no t-block, so B is a cycle. We wish to show that G is a bundle of balloons. From property (3), G must consist of B and balloons with tips in B . We proceed to show that the vertex boundaries of those balloons share a single common vertex.

Suppose B is a cycle and A_1 and A_2 are balloons with tips u and v . Fix an orientation of B and let $B_1 = B[u, v]$ and $B_2 = B[v, u]$. Note that $A_1 \cup A_2 \cup B_i$ is a bicycle for $i \in \{1, 2\}$, so $b_1 = b_2$. Since this argument applies to any two balloons, we can see that there is no balloon A_3 attached at $w \notin \{u, v\}$. Note also that $B \cup A_i$ is a bicycle for each $i \in \{1, 2\}$, so $a_1 = a_2$. We now have $\eta = 2a_1 + b_1 = a_1 + 2b_1$,

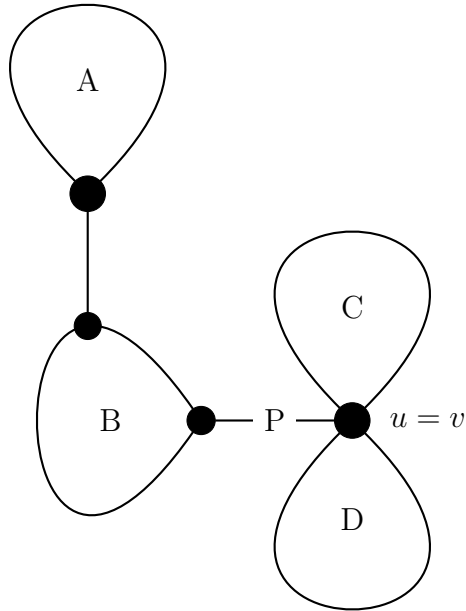

FIGURE 4.2. A subgraph that intersects B at precisely one vertex

and hence $a_1 = b_1$, $\eta = 3a_1$. If there is a third balloon A_3 attached at u , then by the argument above $a_3 = a_1$. The bicycle $A_1 \cup A_3$ has length $2a_1$ but $\eta = 3a_1$; a contradiction. Thus there is at most one balloon attached at u , and similarly at v . Now A_2 can be unrolled to u , leaving a graph G' representing M which has fewer balloons than G . This contradicts our choice of G . Hence there is no balloon A_2 attached at v . This shows that all balloons share a single common tip, and hence G is a bundle of balloons. \square

In the case that G has no t-block, we have shown that it is a bundle of balloons. To complete the proof of Theorem 4.1, we now consider with the case that G does

have a t-block B with branch vertices $\{u, v\}$ and arms B_1, \dots, B_n . We will show that G is a subdivision of one of the graphs shown in Figure 3.2. Hence M is one of the matroids specified in the theorem.

Applying the arguments from the proof of (4) above to any cycle $B_i \cup B_j$ in B , we find that the vertex boundary of B can meet balloons in at most two vertices, which must be equidistant along the cycle. Suppose there are balloons A_1 and A_2 with tips x_1 and x_2 , respectively, and assume without loss that $x_i \in V(B_i)$. Note that each of the following is a bicycle.

$$B_1 \cup B_2 \cup B_3 \quad A_1 \cup B_1 \cup B_2 \quad A_1 \cup B_1 \cup B_3 \quad A_2 \cup B_1 \cup B_2 \quad A_2 \cup B_2 \cup B_3$$

So we have $a_1 = a_2 = b_1 = b_2 = b_3$ and $\eta = 3a_1$. Now the subgraph $A_1 \cup A_2 \cup B_3$ is contained in some bicycle. Since this subgraph includes η edges, it must be a bicycle. So each of A_1 and A_2 must meet B_3 , and we find $\{x_1, x_2\} = \{u, v\}$. Suppose without loss that $x_1 = u$. There must at least one other balloon A_3 with tip u . Otherwise A_1 can be unrolled to v to obtain a representation with fewer balloons. From symmetry $a_1 = a_3$, and since $A_1 \cup A_3$ is a bicycle we have $\eta = 2a_1$; a contradiction. So G does not have balloons with two distinct tips.

Now consider the case that exactly one vertex in the boundary of B is a balloon tip. If this vertex is u , then each balloon can be unrolled to v , leaving a graph G' representing M with fewer balloons than G . Similarly if the tip is v they may be unrolled to u . If exactly one balloon has tip $x \notin \{u, v\}$, it can be unrolled to v . So we are left with the case that there are at least two balloons, A_1 and A_2 , with shared

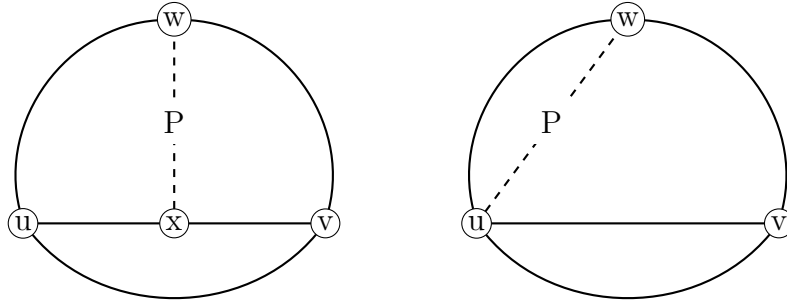

FIGURE 4.3. A single t-block with precisely three arms

tip $x \notin \{u, v\}$. Assume $x \in B_1$. By symmetry $a_1 = a_2$, and since $A_1 \cup A_2$ is a bicycle we have $\eta = 2a_1$. Also by symmetry $b_2 = b_3$. Since $B_1 \cup B_2 \cup B_3$ is a bicycle we have $b_1 + 2b_2 = \eta = 2a_1$. The bicycles $B_1 \cup B_2 \cup A_1$ and $B_1 \cup B_2 \cup B_3$ show $b_3 = a_1$, so we're left with $2a_1 = b_1 + 2b_2 = b_1 + 2b_3 = b_1 + 2a_1$; a contradiction. Hence there are no balloons attached to B .

When $n \geq 4$, any three arms of B form a bicycle. By symmetry, each arm is of the same length, $\eta/3$. Suppose there is some path P from B_i to B_j internally disjoint from the arms of B , where P is not itself an arm. (We allow the possibility that $i = j$). Assume without loss that there is a vertex $w \in P \cap B_1$ with $w \notin \{u, v\}$, and that $j \in \{1, 2\}$. Then $B_1 \cup B_2 \cup P$ forms a bicycle, so $p = \eta/3$. But $B_1[w, u] \cup P \cup B_2 \cup B_3$ is contained in a bicycle of size strictly larger than $p + b_2 + b_3 = \eta$. Hence there can be no such path P . So if B has at least 4 arms, then G is exactly the union of those arms, and M is a $\eta/3$ -subdivision of $U_{2,n}$.

It remains to consider with the case $n = 3$, where G is a single t-block B with exactly three arms.

Suppose there is some path P from B_1 to B_2 internally disjoint from the arms of B . Assume without loss that $P \cap B_1 = w \notin \{u, v\}$, and let $x = P \cap B_2$. (Figure 4.3)

If $x \notin \{u, v\}$, consider the 6 paths $B_1[u, w]$, $B_1[w, v]$, $B_2[u, x]$, $B_2[x, v]$, B_3 , P . Any 5 of these together will form a bicycle. By symmetry, each is of the the same size, p , and $\eta = 5p$. Note that since this argument applies to any B_i to B_j paths, it precludes any such paths except those from w to x . But if Q is a w, x path internally disjoint from the arms of B , and $q = p$, then $B_1[u, w] \cup B_2[u, w] \cup P \cup Q$ is a bicycle of size $4p < \eta$. So we find that no such Q exists. Hence G represents a p -subdivision of $U_{4,6}$.

Now suppose $x = u$. Consider the 5 paths $B_1[u, w]$, $B_1[w, v]$, B_2 , B_3 , P . Any 4 of these together form a bicycle, so each is of size p , and $\eta = 4p$. If Q is another w, x path, then $B_1[u, x] \cup P \cup Q$ is a bicycle of size $3p$. Hence no Q exists, and G represents a p -subdivision of $U_{3,5}$

Finally, suppose there is a non-trivial path P from B_1 to B_1 internally disjoint from the arms of B . Assume that $P \cap B_1 = \{w, x\}$ with $\{w, x\} \cap \{u, v\} = \emptyset$ and such that $R = B_1[u, w]$, $S = B_1[w, x]$, and $T = B_1[x, v]$ partition the edges of B_1 . By symmetry we see that $b_2 = b_3$, that $p = s$, and that $r = t$. Consider each of the following bicycles of G .

$$B_1 \cup B_2 \cup B_3 \quad B_2 \cup B_3 \cup R \cup S \cup P \quad B_1 \cup B_2 \cup P$$

The first gives $\eta = b_1 + b_2 + b_3 = r + s + t + 2b_2 = 2r + s + 2b_2$. The second gives $\eta = b_2 + b_3 + r + s + p = r + 2s + 2b_2$. The third gives $\eta = b_1 + b_2 + p = r + s + t + b_2 + p =$

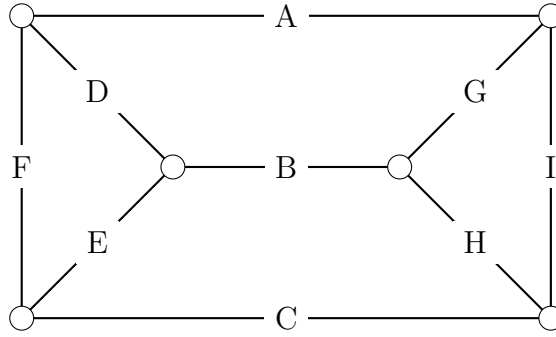

FIGURE 4.4. The prism graph P_6

$2r + 2s + b_2$. Hence $r = s = b_2 (= t = b_1 = b_3 = p)$, and $\eta = 5p$. Here G represents a p -subdivision of $U_{4,6}$

□

2. Bicircular Matroids with Circuits of Two Sizes

The second main result of the dissertation is given next. It is a partial extension of Theorem 4.1 to bicircular matroids with circuits of two cardinalities. A complete extension of that theorem would require dropping the condition that the graph G is a subdivision of a 3-connected graph from Theorem 4.2. An (a, b) -subdivision of a graph, for distinct positive integers a and b , is obtained by subdividing each edge of the graph into a path of length a or a path of length b so that there is at least one path of each of these lengths after the subdivision. The prism graph is given in Figure 4.4.

THEOREM 4.2. *Let $M = B(G)$ be a connected bicircular matroid where G is a subdivision of a 3-connected graph H . Then $|\text{spec}(M)| = 2$ if and only if H is one of the following graphs.*

- (1) *An (a, b) -subdivision of W_3 for distinct positive integers a and b .*
- (2) *A k -subdivision of W_4 , $K_5 \setminus e$, K_5 , $K_{3,3}$, $K_{3,4}$, or the prism P_6 for some $k \in \mathbb{Z}^+$. If H is isomorphic to W_4 , $K_5 \setminus e$, or K_5 , then $\text{spec}(M) = \{5k, 6k\}$. If H is isomorphic to $K_{3,3}$, $K_{3,4}$, or P_6 , then $\text{spec}(M) = \{6k, 7k\}$.*

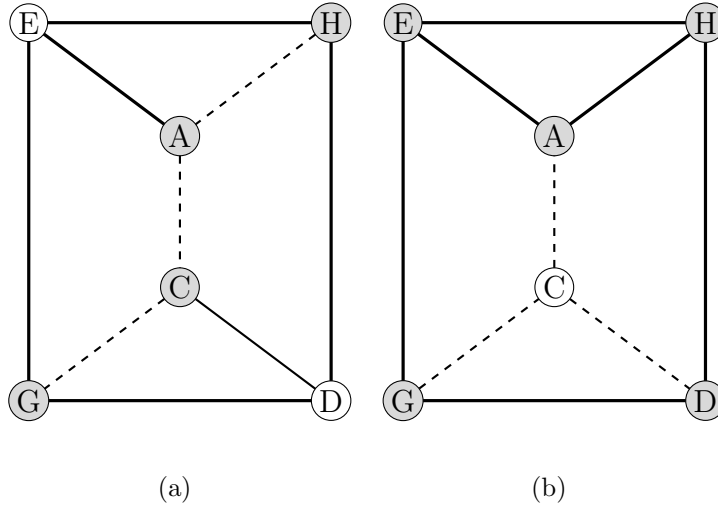

FIGURE 4.5. A couple of 2-edge colorings of the prism

The next concept is crucial to the proof Theorem 4.2. We use this concept to connect the problem of determining the graphs with few bicycle sizes with an edge coloring of graphs that follows certain rules. The vertex and edge sets of a graph G are denoted by $V(G)$ and $E(G)$, respectively. Note that the vertex- and edge-labeling functions considered below are not required to be injective as is common in graph labeling problems (see [5, 6]). This is because we are considering problems involving

bicycle sizes in certain matroids. The bicycle sizes will be the “color” of certain edges in an associated graph. As we have few bicycle sizes, we will have many repeated edge colors in our graphs.

DEFINITION 4.3. *Let G be a simple graph, $\varphi : V(G) \rightarrow \mathbb{Z}^+$, and $j \in \mathbb{Z}^+$.*

- (1) *We say that φ is a j -vertex coloring of G if $|\{\varphi(A) : A \in V(G)\}| = j$.*
- (2) *We say that φ is a j -edge coloring of G if $|\{\varphi(A) + \varphi(B) : AB \in E(G)\}| = j$.*

Let G be a simple graph with a fixed j -vertex coloring φ . Suppose that A and B are distinct vertices of G . We refer to a number $\varphi(A)$ as the “color” of a vertex A . We refer to a number $\varphi(A) + \varphi(B)$ as the “color” of an edge AB . Typically we will use the convention that $\varphi(A) = a$ for each vertex A so that $a + b$ will be the color of an edge AB . The graph G will be said to be *vertex-monochromatic* if φ is a 1-vertex coloring. The graph G will be said to be *edge-monochromatic* if φ is a 1-edge coloring. If G is vertex-monochromatic, then it will be edge-monochromatic but not conversely. Two 2-edge colorings of the prism graph are illustrated in Figure 4.5. In that figure the dashed edges represent one edge color class and the bold edges represent the other. The shaded vertices are one vertex-color class and the non-shaded vertices are the other.

LEMMA 4.4. *Let G be a connected graph with a 2-edge coloring φ .*

- (1) *If U and V are vertices of G connected by an edge-monochromatic path of even length, then $\varphi(U) = \varphi(V)$.*

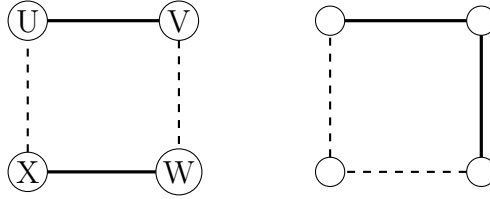

FIGURE 4.6. An alternating four-cycle

- (2) *If a four-cycle is not edge-monochromatic, then opposite edges of the four-cycle have different colors.*
- (3) *If G is a prism graph, then, up to symmetry, the edges of G are as colored in Figure 4.5 (a) or (b). In these two cases the coloring is a 2-vertex coloring.*
- (4) *If φ is a 2-vertex coloring, then one of the vertex color classes is an independent set of vertices.*
- (5) *If a neighbor of a vertex V is adjacent to vertices of two different colors, then V has one of these two colors.*

PROOF. Let the edge colors of G be “dash” and “bold” and picture the edges appropriately in diagrams. Suppose that UVW are the vertices of a path of G of length two listed in order with monochromatic edges. Then $u + v = v + w$ so that $u = w$. Extend this observation by induction to obtain Lemma 4.4 (1).

Suppose that $UVWX$ are the vertices of a four-cycle of G listed in cyclic order. Assume that exactly three of the edges are monochromatic, say $u + v = v + w = w + x$ without loss of generality. Then apply (1) to the path UVW to obtain that $u = w$ and apply (1) to the path VWX to obtain that $v = x$. Hence $u + x = w + v$ and the edges of the four-cycle are monochromatic; a contradiction. Hence the four-cycle

of G has precisely two edges of each color. Suppose that (2) does not hold. Then we may assume that $u + v = x + w$ and $u + x = v + w$ and these two colors are different (see Figure 4.6 (a)). Then $u + v - w = x = v + w - u$ so that $u = w$. Hence $u + v = w + v$; a contradiction. Hence Lemma 4.4 (2) holds and the four-cycle is as colored in Figure 4.6 (b) up to symmetry. Hence Lemma 4.4 (2) holds.

Suppose that $G \cong P_6$ and that the vertices of G are as labeled in either of the graphs given in Figure 4.5. The symmetry of the graph allows us to assume that any of the three four-cycles of G is the exterior cycle. Let n denote the number of edge-monochromatic four-cycles of G . Then $n \neq 3$ as two colors are used on the edges of G . Assume that $n = 2$. It follows by symmetry that we may assume that the cycles $ACGEA$ and $ACDHA$ are edge-monochromatic of the same color. Then (1) implies that the vertices of G are monochromatic; a contradiction. Hence $n \neq 2$. Suppose that $n = 0$. Then (2) implies that edges EG and AC have different colors and that edges AC and DH have different colors. Hence edges EG and DH have the same color. This contradicts (2) applied to the cycle $DGEHD$. Hence $n = 1$.

We may suppose that the cycle $EGDHE$ is edge-monochromatic of color bold by symmetry. Then the edges of the cycle $ACGEA$ are not. Apply (2) to this cycle to obtain that the edge AC is dashed and exactly one of the edges AE and CG is dashed. Suppose the latter by symmetry. Edge AH is either dashed or bold. Suppose the former holds. Then the edges of G are as colored in Figure 4.5 (a). Moreover, (1) implies that $a = c = g = h$ and $d = e$. Hence the two edge colors of K are $a + h = 2a$ and $a + e = a + d$. Now suppose that edge AH is bold. Apply (2) to the cycle $AHDCA$

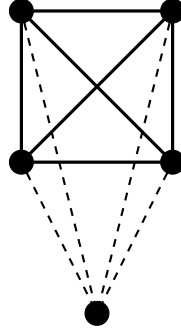

FIGURE 4.7. A 2-edge coloring of K_5

to obtain that edge CD is dashed. Hence (1) implies that $a = d = e = g = h$ and $c \neq a$. This completes the proof of Lemma 4.4 (3).

Now suppose that the vertices of G are colored with two colors, say a and b with $a \neq b$. If neither of the vertex-color classes of G is an independent set, then G has edges colored $2a$ and $2b$. It follows from G being connected that G has an edge colored $a + b$. Hence G has edges of three distinct colors; a contradiction. This completes the proof of Lemma 4.4 (4).

Suppose that V is adjacent to a vertex U with two other neighbors of colors a and b with $a \neq b$. The two edge-colors of G must be $u + a$ and $u + b$. Hence the color of the edge UV must be one of these two values. then $u + v = u + a$ or $u + v = u + b$ so that $v \in \{a, b\}$. This completes the proof of Lemma 4.4 (5). \square

LEMMA 4.5. *Let $G \cong K_n$ have a 2-edge coloring for some $n \geq 4$. Then the edges of one color induce a subgraph isomorphic to K_{n-1} and the edges of the other color induce a subgraph isomorphic to $K_{1,n-1}$ and exactly one vertex is of one color, $n - 1$ vertices are of the other color.*

PROOF. Let the vertex set of G be $\{V_1, V_2, \dots, V_n\}$ with vertex V_i having color v_i for each i . Let H be a maximal complete vertex-monochromatic subgraph of G with vertex set, say $\{V_1, V_2, \dots, V_j\}$ without loss of generality. The edge set of G is not monochromatic so that $j < n$. Let the edge colors of G be “bold” and “dash”.

Suppose that $j = 2$. Then G contains no edge-monochromatic triangles. It follows from Lemma 4.4 (2) that G either contains an edge-monochromatic four-cycle or a four-cycle with opposite edges having different colors. If the latter occurs, then one of the chords of the four-cycle will complete an edge-monochromatic triangle with two of the edges of the cycle; a contradiction. Hence the former occurs and the two chords of the four-cycle have the opposite color of the edges of the four-cycle. However, these two chords are opposite edges of a four-cycle that have the same color; a contradiction to Lemma 4.4 (2). Hence $j \geq 3$. Then the vertices of H are monochromatic of color v_1 by Lemma 4.4 (1). Let bold be the color of the edges of H . Assume that some edge $V_i V_k$ is bold for $i \leq j < k$. Then vertex V_k has color v_1 by Lemma 4.4 (1). Then each edge from V_k to $\{V_1, V_2, \dots, V_j\}$ has color $2v_1$ so that $V(H) \cup \{V_k\}$ induces an edge-monochromatic subgraph of G . This contradicts the choice of H . Hence all edges $V_i V_k$ are colored dash for $i \leq j < k$.

Assume that $j < n - 1$. Then each vertex of $\{v_{j+1}, v_{j+2}, \dots, v_n\}$ has color v_n by Lemma 4.4 (1). Thus the edge colors of G include $v_1 + v_2 = 2v_1$, $v_1 + v_n$, and $v_{n-1} + v_n = 2v_n$. Two of these three sums must be the same so that $v_1 = v_n$. It follows that the vertices of G are monochromatic; a contradiction. Hence $j = n - 1$ (see Figure 4.7 for an example of such a coloring when $n = 5$). \square

Dirac provided the following result in 1963 [4] (see [1] for an alternate proof and [7] for an exposition). The graphs W_r , K_5 , and $K_{3,p}$ were given in Figure 1.2. The graph $K_5 \setminus e$ is obtained by deleting a single edge of K_5 . The graphs $K'_{3,p}$, $K''_{3,p}$, and $K'''_{3,p}$ are obtained from $K_{3,p}$ by adding, respectively, one, two, or three edges to the partite class of size three.

THEOREM 4.6. *A graph G is a subdivision of a simple 3-connected graph without two vertex-disjoint cycles if and only if G is isomorphic to a subdivision of one of the following graphs: a wheel graph, K_5 , $K_5 \setminus e$, $K_{3,p}$, $K'_{3,p}$, $K''_{3,p}$, or $K'''_{3,p}$ for some $p \geq 3$.*

Note that in the proof of the lemma below, and throughout the remainder of the dissertation, we again use the convention that an uppercase letter represent a subgraph of a graph, while the corresponding lowercase letter represents the number of edges in that subgraph. This convention will mesh nicely with the convention for coloring the vertices and edges of graphs as in Definition 4.3.

LEMMA 4.7. *Suppose that G is isomorphic to a subdivision of W_r ($r \geq 3$), K_5 , $K_5 \setminus e$, $K_{3,p}$, $K'_{3,p}$, $K''_{3,p}$, or $K'''_{3,p}$ ($p \geq 3$). Let $M = B(G)$. Then $|\text{spec}(M)| = 2$ if and only if G is to one of the following graphs.*

- (1) An (a, b) -subdivision of W_3 for distinct positive integers a and b .
- (2) A k -subdivision of W_4 , $K_5 \setminus e$, K_5 , $K_{3,3}$, or $K_{3,4}$ for some $k \in \mathbb{Z}^+$.

PROOF. First note that each graph represent a bicircular matroid with bicycles of two cardinalities. Suppose that $|\text{spec}(M)| = 2$. Let S denote the edge set of

G . First assume that H is a wheel-graph. Let G be as given in Figure 1.2 (a) with A_i and B_i denoting paths of G obtained by subdividing an edge of H for each $i \in \{1, 2, \dots, r\}$. Hence A_i has a_i edges and B_i has b_i edges, for each i , by following our convention. Assume that a subdivision of $G \cong W_3$. Then $S - A_i$ and $S - B_i$ are bicycles of G for each $i \in \{1, 2, 3\}$. These bicycles are of two cardinalities so that $\{a_1, a_2, a_3, b_1, b_2, b_3\} = \{a, b\}$ for some distinct positive integers a and b . It follows that G is obtained from W_3 by either an a -subdivision or a b -subdivision of each edge where $a \neq b$ are positive integers.

Assume that H is isomorphic to W_r for some $r \geq 4$. Define $A = A_1 \cup A_2 \cup \dots \cup A_r$ and $B = B_1 \cup B_2 \cup \dots \cup B_r$. Note that the positive integers a and b subsequently defined will not be related to the cardinalities of A and B in what follows as an exception to our coloring rules. Now $\{A_i, A_j\} \cup B$ is a theta-graph for distinct $i, j \in \{1, 2, \dots, r\}$. Thus there are at most two values for the sums $a_i + a_j$, $i \neq j$. Let $Z(G)$ be the complete graph with vertex set $\{A_1, A_2, \dots, A_r\}$. Color each vertex A_i with color a_i and each edge with the sum of the colors of its endvertices. This coloring yields a j -edge coloring of $Z(G)$ for $j \in \{1, 2\}$. If $j = 2$, then we may assume that (\dagger) holds by symmetry. If $j = 1$, then (\ddagger) holds.

$$(\dagger) \ a_1 = a_2 = \dots = a_{r-1} = a \text{ and } a_r = b \neq a \text{ or}$$

$$(\ddagger) \ a_1 = a_2 = \dots = a_r = a \text{ for some } a, b \in \mathbb{Z}^+.$$

Assume that G is a subdivision of W_4 . Then the sets $\{B_i, B_{i+1}, A_{i+1}\}$, $\{A_i, A_j\}$, $\{B_i, B_{i+2}\}$, $\{B_i, A_{i+2}\}$, $\{B_i, A_{i+3}\}$ for distinct $i, j \in \{1, 2, 3, 4\} \pmod 4$ are complements of bicycles of G . Hence $2 = |Z|$ where Z is the set $\{a_1 + b_1 + b_4, a_2 + b_1 + b_2,$

$a_3 + b_2 + b_3, a_4 + b_3 + b_4, a_1 + a_2, a_1 + a_3, a_1 + a_4, a_2 + a_3, a_2 + a_4, a_3 + a_4, b_1 + b_3, b_2 + b_4, b_1 + a_3, b_1 + a_4, b_2 + a_1, b_2 + a_4, b_3 + a_1, b_3 + a_2, b_4 + a_2, b_4 + a_3 \}$.

CASE 1. Suppose that (\dagger) holds so that $Z = \{2a, a + b, a + b_1 + b_4, a + b_1 + b_2, a + b_2 + b_3, b + b_3 + b_4, b_1 + b_3, b_2 + b_4, b_1 + a, b_1 + b, b_2 + a, b_2 + b, b_3 + a, b_4 + a\}$.

Note that (\dagger) each sum in Z is equal to $2a$ or $a + b$ as $a \neq b$ so that $2a \neq a + b$. Then $|\{a + b_1 + b_2, a + b_1, a + b_2\}| \leq 2$. Hence $a + b_1 = a + b_2$. Thus $b_1 = b_2$. So $Z = \{2a, a + b, a + b_1 + b_4, a + 2b_1, a + b_1 + b_3, b + b_3 + b_4, b_1 + b_3, b_1 + b_4, b_1 + a, b_1 + b, b_3 + a, b_4 + a\}$. Likewise, $a + b_1 + b_3$ is neither $b_1 + a$ nor $b_3 + a$ so $b_1 + a = b_3 + a$. Thus $b_3 = b_1$. Hence $Z = \{2a, a + b, a + b_1 + b_4, a + 2b_1, b + b_1 + b_4, 2b_1, b_1 + b_4, b_1 + a, b_1 + b, b_4 + a\}$. Now $b + b_1 + b_4$ is neither $b_1 + b_4$ nor $b_1 + b$. Hence $b_1 + b_4 = b_1 + b$. Hence $b_4 = b$ and $Z = \{2a, a + b, a + b + b_1, a + 2b_1, 2b + b_1, 2b_1, b_1 + b, b_1 + a\}$. Now $|\{a + b, a + b + b_1, b_1 + b\}| \leq 2$ implies that $a + b = b_1 + b$. Hence $a = b_1$ and $Z = \{2a, a + b, 2a + b, 3a, a + 2b\}$. Then $|\{2a, a + b, 2a + b\}| \leq 2$. However, these three sums are pairwise distinct because $a \neq b$; a contradiction. Thus Case 2 occurs.

CASE 2. Suppose that (\ddagger) holds so that $Z = \{2a, a + b_1 + b_4, a + b_1 + b_2, a + b_2 + b_3, a + b_3 + b_4, b_1 + b_3, b_2 + b_4, b_1 + a, b_2 + a, b_3 + a, b_4 + a\}$.

As before $|\{a + b_i + b_j, a + b_i, a + b_j\}| \leq 2$ for distinct $i, j \in \{1, 2, 3, 4\}$ so that $b_1 = b_2 = b_3 = b_4$. Hence $Z = \{2a, a + 2b_1, 2b_1, a + b_1\}$. Then $|\{a + 2b_1, 2b_1, a + b_1\}| \leq 2$ so that $b_1 = a$. Thus $Z = \{2a, 3a\}$ and $a_i = a_j = b_i = b_j$ for all $i, j \in \{1, 2, 3, 4\}$. Then G is a k -subdivision of W_4 where $k = a$.

Now assume that H is isomorphic to W_r for $r \geq 5$. Then the graph obtained from G by deleting the edge set of $r-4$ consecutive spoke paths of G is a subdivision of W_4 . By the previous remarks, each subdivision path of such a W_4 with the given coloring has the same number of edges. Each of the paths A_i and B_j is in such a subgraph so that this common number is $a_i = b_j = b_1$ for any $i, j \in \{1, 2, \dots, r\}$. Remove the paths A_1, A_2, \dots , and A_{r-4} to obtain a subdivision of W_4 with $B_r \cup B_1 \cup B_2 \cup \dots \cup B_{r-4}$ being a subdivision path. This path has b_1 edges so that $b_r + b_1 + b_2 + \dots + b_{r-4} = b_1$; a contradiction.

Suppose that H is isomorphic to K_5 . Assume that H is given in Figure 4.8 where each labeled edge X corresponds to a path X of G of length x . Then each of the labeled paths is in a subgraph of G that is a subdivision of W_4 . Hence each of these paths has length k . The paths P and Q are in bicycles of G with $5k$ and $6k$ edges. Hence G is isomorphic to k -subdivision of K_5 and $\text{spec}(M) = \{5k, 6k\}$. Likewise, if H is isomorphic to $K_5 \setminus e$, then $\text{spec}(M) = \{5k, 6k\}$.

Suppose that H is isomorphic to $K_{3,3}$, where the subdivision paths of G are as given in Figure 1.2 with path A_i corresponding to edge Ai , path B_i corresponding to edge Bi , and path C_i corresponding to edge Ci , for $i = 1, 2, 3$. Then the edge sets of $A_1 \cup A_2 \cup A_3$, $B_1 \cup B_2 \cup B_3$, $C_1 \cup C_2 \cup C_3$, $A_i \cup B_j$, $A_i \cup C_j$, and $B_i \cup C_j$ for $i, j \in \{1, 2, 3\}$ with $i \neq j$ are complements of bicycles of G . Hence the above sets are of two cardinalities.

Let $Z(G)$ be the graph with vertex set $\{A_1, A_2, A_3, B_1, B_2, B_3, C_1, C_2, C_3\}$ and edges $A_i B_j$, $A_i C_j$, and $B_i C_j$ for $i, j \in \{1, 2, 3\}$ with $i \neq j$. Color a vertex X by

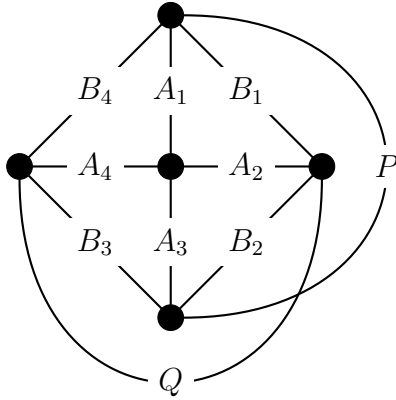

FIGURE 4.8. Adding paths to a subdivision of W_4

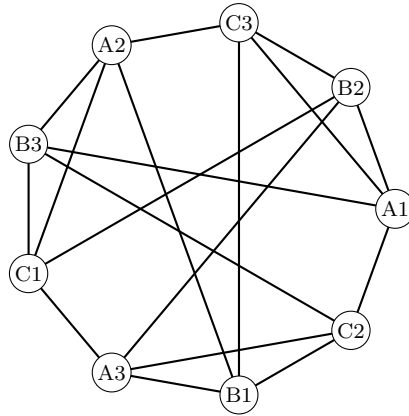

FIGURE 4.9. A bicycle graph associated with $K_{3,3}$

x , the number of edges in the path X of G , and color an edge XY by $x + y$. This coloring yields a j -edge coloring of $Z(G)$ for $j \in \{1, 2\}$. If $j = 1$, then $a_1 = a_2 = a_3 = b_1 = b_2 = b_3 = c_1 = c_2 = c_3 = k$ for some $k \in \mathbb{Z}^+$. Then G is a k -subdivision of $H \cong K_{3,3}$ and each bicycle of G has $6k$ or $7k$ edges. Suppose that $j = 2$.

We claim that this is a 2-vertex coloring of $Z(G)$. The graph of $Z(G)$ is given in Figure 4.9. The subgraphs induced by deleting a triangle $\{A_i, B_j, C_k\}$ with $i \neq j$,

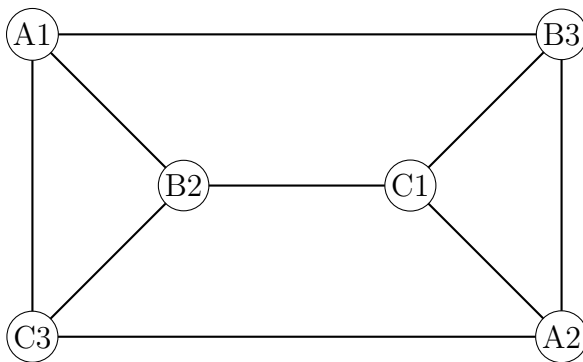

FIGURE 4.10. The prism graph Q

$\neq k$, and $i \neq k$ are all prism graphs. At least one of these prism graphs is not edge-monochromatic as $Z(G)$ is not. By symmetry, assume that Q is two-edge colored where Q is the subgraph induced by the vertices A_1, B_2, C_3, A_2, B_3 , and C_1 (see Figure 4.10).

The vertices and edges of Q are colored as in Figure 4.5 (a) or (b) by Lemma 4.4 (3). If $V \in \{A_3, B_1, C_2\}$, then V is adjacent to three of the vertices of Q . Then Lemma 4.4 (5) implies that V has one of the two vertex-colors used on Q because V is adjacent to some vertex of Q that is adjacent to vertices of different colors. Thus the vertex set of $Z(G)$ is two-colored.

Assume that the vertex sets $A := \{A_1, A_2, A_3\}$, $B := \{B_1, B_2, B_3\}$, and $C := \{C_1, C_2, C_3\}$ are each vertex-monochromatic. Then Lemma 4.4 (1) implies that $Z(G)$ is vertex-monochromatic; a contradiction. Hence we may assume that A is not vertex-monochromatic so that $a_1 = a_2 = a$ and $a_3 = b$ with $a \neq b$ for some positive integers a and b . Assume that either B or C is vertex-monochromatic, say B by symmetry. Then the vertex color of B is either a or b . If the former holds, then $a_1 + a_2 + a_3 = 2a + b$,

$b_1 + b_2 + b_3 = 3a$, the edge A_1B_2 has color $2a$, and the edge A_3B_2 has color $a + b$. Hence $|\{2a + b, 3a, 2a, a + b\}| \leq 2$. It follows from $a + b = 3a$ that $b = 2a$. Then $\{2a + b, 3a, 2a, a + b\} = \{2a, 3a, 4a\}$; a contradiction. Hence the latter holds and $a_1 + a_2 + a_3 = 2a + b$, $b_1 + b_2 + b_3 = 3b$, the edge A_1B_2 has color $a + b$, and the edge A_3B_2 has color $2b$. Then $|\{2a + b, 3b, a + b, 2b\}| \leq 2$. It follows from $a + b = 3b$ that $a = 2b$. Then $\{2a + b, 3b, a + b, 2b\} = \{2b, 3b, 5b\}$; a contradiction. Hence B , and likewise C are not vertex-monochromatic sets.

There exists an edge A_iB_j of color $2a$ and one of color $a + b$ since each vertex B_j has two neighbors in A and at least one of these vertices has color a . However, these two colors and the sum $a_1 + a_2 + a_3 = 2a + b$ are all pairwise different; a contradiction.

Suppose that $H \cong K_{3,p}$ for some integer p exceeding three. Then delete any $p - 3$ of the vertices of the classes of size p of G to obtain that any such path is in a subdivision of $K_{3,3}$. Thus each such path has the same number, say k , of edges by the previous arguments. The graph $K_{3,p}$ only has bicycles of two sizes when $p = 4$ in this case. When $p = 4$, G will have bicycles of cardinality $6k$ and $7k$.

Note that $K'_{3,p}$ has bicycles of cardinalities 5, 6, and 7 for all $p \geq 3$. If H is isomorphic to this graph, then the paths between the partite classes of G have the same number of edges, say k , by previous arguments. Let p be the number of edges in the path between two vertices of the partite class of size three of G . Then G has bicycles of size $4k + p$, $6k + p$, $6k$, and $7k$. At least three of these cardinalities are different; a contradiction.

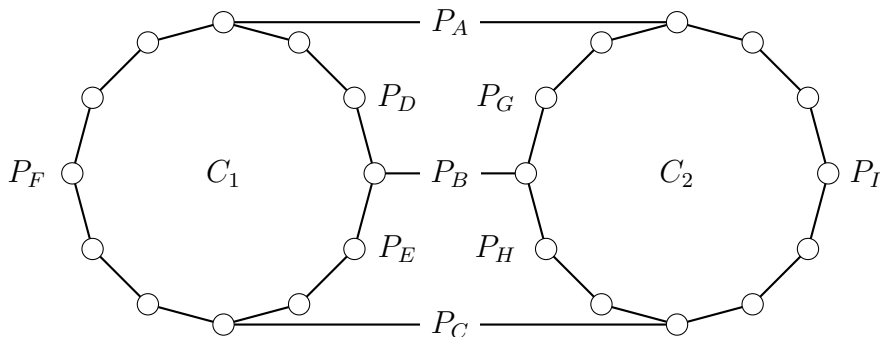

FIGURE 4.11. Two vertex-disjoint cycles

Likewise, we obtain a contradiction if H is isomorphic to $K''_{3,p}$ or $K'''_{3,p}$ as G will contain bicycles of three different cardinalities. This completes the proof of Lemma 4.7. \square

THEOREM 4.8. *Let G be a subdivision of a simple 3-connected graph with two vertex-disjoint cycles. For $M = B(G)$, $|\text{spec}(M)| = 2$ if and only if G is isomorphic to a k -subdivision of the prism graph for some $k \in \mathbb{Z}^+$. In this case $\text{spec}(M) = \{6k, 7k\}$.*

The next lemma follows from an observation of H. Wu. It is a key part of the proof of Theorem 4.8.

LEMMA 4.9. *Suppose that C_1 and C_2 are distinct vertex-disjoint cycles in a graph G . Let paths P_X from C_1 to C_2 , for $X \in \{A, B, C, D, E, F, G, H, I\}$, be as given in Figure 4.11, where the length of P_X is $x > 0$. Let S consist of the edge set of these two cycles and nine paths. If the bicycles of $B(G[S])$ have exactly two different sizes, then $x = y$ for all $x, y \in \{a, b, c, d, e, f, g, h, i\}$.*

PROOF. Note that $S - (P_X \cup P_Y)$ is a bicycle of $B(G[S])$ for $\{XY\} \in \{AB, AC, BC, BF, CD, AE, AH, BI, CG, FI, FG, FH, DG, DH, DI, EG, EH, EI\}$. Likewise, $S - (P_X \cup P_Y \cup P_Z)$ is a bicycle of $B(G[S])$ for $\{XYZ\} \in \{ADF, BDE, CEF, AGI, BGH, CHI\}$. Each of these bicycles has one of two edge set cardinalities. Hence for such pairs (X, Y) and triples (X, Y, Z) above, $x + y$ and $x + y + z$ take one of two distinct values. These eighteen two-sums and six three-sums are listed in Table 1.

Let K be the graph on vertex set $A, B, C, D, E, F, G, H, I$ with vertices joined by an edge if the corresponding two-sum is listed the table (see Figure 4.12). Color each vertex X of K by x and each edge XY by $x + y$. This coloring yields a j -edge coloring of K for $j \in \{1, 2\}$. First suppose that $j = 2$. We will denote the two colors by “bold” and “dash” and indicate these colors by using thick and dashed edges, respectively, in our drawings.

The subgraphs $L_i, i \in \{1, 2, 3\}$, of K are given in Figure 4.13. We claim that the vertices of each graph $L_i, i \in \{1, 2, 3\}$, are monochromatic.

Consider the six vertex triples of K corresponding to each of the triples in Table 1. Such a vertex triple meets the vertex set of each prism graph L_i precisely twice in a

$a + b$	$b + f$	$a + h$	$f + i$	$d + g$	$e + g$	$a + d + f$	$a + g + i$
$a + c$	$c + d$	$b + i$	$f + g$	$d + h$	$e + h$	$b + d + e$	$b + g + h$
$b + c$	$a + e$	$c + g$	$f + h$	$d + i$	$e + i$	$c + e + f$	$c + h + i$

TABLE 1. Sums that take on two different values

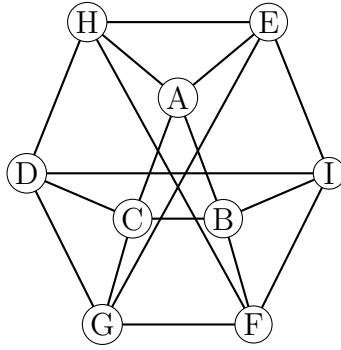

FIGURE 4.12. The graph K

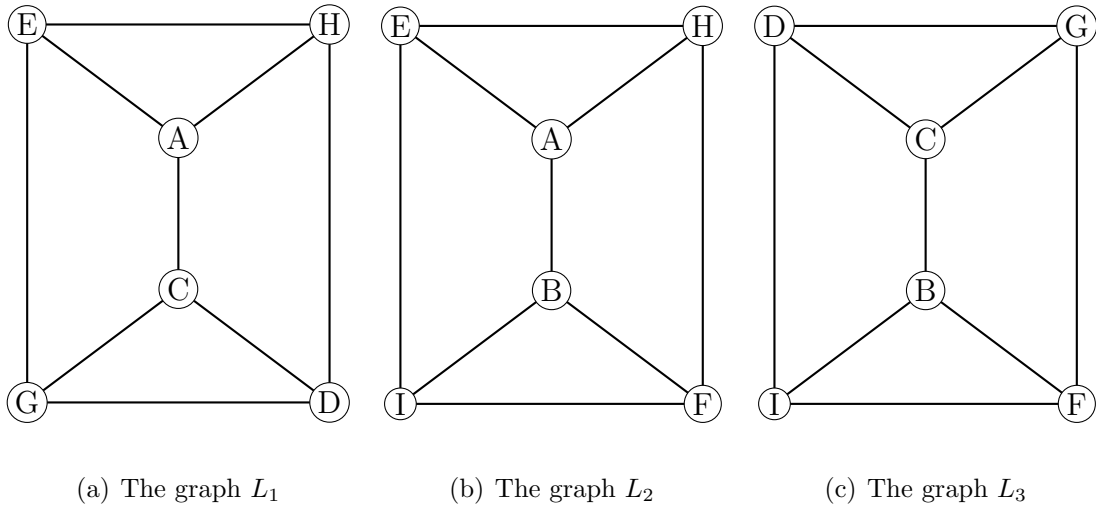

FIGURE 4.13. Three subgraphs of K

symmetric manner. For example, the triples $\{a, d, f\}$, $\{a, g, i\}$, $\{c, e, f\}$, and $\{c, h, i\}$ meet the vertex set of L_1 in an interior vertex and a nonadjacent vertex on the cycle bounding the exterior face. The triples $\{d, e, b\}$ and $\{g, h, b\}$ meet the vertex set of L_1 in nonadjacent vertices of the exterior face. The third vertex of the triple is not in L_1 . We will only use the fact that the color of the third vertex is positive in what follows. We now assume that the vertex set of L_1 is not monochromatic. We will use the six triples above to obtain a contradiction. It will then follow by symmetry the vertex

set of each graph L_i is monochromatic so that the vertex set of K is monochromatic and $j = 1$. Note that the symmetry mentioned above also allows us to assume that any of the three four-cycles of each prism graph of Figure 4.13 is the cycle bounding the exterior face. Hence we may apply Lemma 4.4 (3) to assume that the vertices and edges of L_1 are as colored in Figure 4.5 (a) or (b) where the edge colors are “bold” and “dash” and the vertices of each color class are denoted by using shading or not.

If L_1 is as colored in Figure 4.5 (a), then the two edge colors are $a + h = 2a$ and $a + e = a + d$. Then the sums $a + d + f$ and $a + g + i = 2a + i$ have color $2a$ or $a + d$. It follows from f and i being positive that $a + d + f = 2a$ and $2a + i = a + d$. Hence $a = d + f$ and $d = a + i$. But this implies that $a > d$ and $d > a$; a contradiction. Hence L_1 is as colored in Figure 4.5 (b). Then the edge colors of K are $a + e = 2a$ and $a + c = c + h$. Then $a + g + i = 2a + i$ and $c + h + i = a + c + i$ have one of these two colors so that $2a + i = a + c$ and $a + c + i = 2a$. It follows that $c = a + i$ and $a = c + i$. This implies that $c > a$ and $a > c$; a contradiction. Hence the edges of K are monochromatic. Then the vertices of K are monochromatic. This completes the proof of Lemma 4.9. □

PROOF OF THEOREM 4.8. First note that the bicircular matroid of a k -subdivision of the prism graph has a spectrum of size two with bicycles of cardinality $\{6k, 7k\}$ for $k \in \mathbb{Z}^+$. For the converse, suppose that $|\text{spec}(M)| = 2$. There exists a subset S of the edge set of G consisting of paths and cycles as given in Figure 4.11 because G is a subdivision of a 3-connected graph. Further, Lemma 4.9 guarantees that the nine

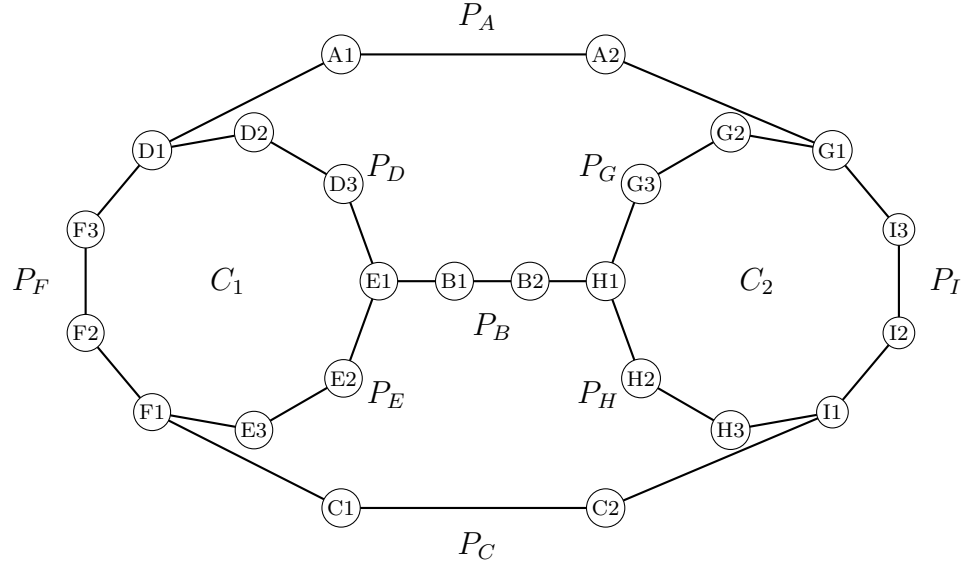

FIGURE 4.14. Bicycles of size $3 \cdot 6$ and $3 \cdot 7$, $k = 3$

labeled paths of Figure 4.11 each have k edges for some $k \in \mathbb{Z}^+$. Relabel the vertices of S so that the vertices of the nine paths given in Figure 4.11 are when listed in order $P_A = \{D_1, A_1, A_2, \dots, A_{k-1}, G_1\}$, $P_B = \{E_1, B_1, B_2, \dots, B_{k-1}, H_1\}$, $P_C = \{F_1, C_1, C_2, \dots, C_{k-1}, I_1\}$, $P_D = \{D_1, D_2, \dots, D_k, E_1\}$, $P_E = \{E_1, E_2, \dots, E_k, F_1\}$, $P_F = \{F_1, F_2, \dots, F_k, D_1\}$, $P_G = \{G_1, G_2, \dots, G_k, H_1\}$, $P_H = \{H_1, H_2, \dots, H_k, I_1\}$, and $P_I = \{I_1, I_2, \dots, I_k, G_1\}$ (See Figure 4.14 for the case $k = 3$ of this construction).

We claim that the edge set of the 2-connected graph G is S . Suppose otherwise. Let $P[U, V]$ be a path with U and V being vertices of S and that is internally disjoint from the vertices of S . First, assume that there exist four internally disjoint paths from C_1 to C_2 in G . Then the endvertices of any three of these paths divide each of C_1 and C_2 into three paths of equal lengths, k . Hence the intersection of the vertex

sets of these four paths and C_1 are D_1, E_1, F_1 , and the intersection of the vertex sets of these four paths and C_2 are G_1, H_1 , and I_1 . We may assume that either $U = D_1$ and $V = G_1$ or $U = D_1$ and $V = H_1$. In either case, $P[U, V]$ has k edges. In the former case $P[U, V] \cup P_A \cup C_1$ is a bow-tie with $5k$ edges; a contradiction. In the latter case, $P[U, V] \cup P_A \cup P_B \cup P_D \cup P_G$ is a theta-graph so that $P[U, V]$ has $2k$ or $3k$ edges; a contradiction. Hence there do not exist four internally-disjoint paths from C_1 to C_2 .

Assume that $P[U, V]$ is a chordal path of C_i for $i = 1, 2$, say $i = 1$. Then $C_1 \cup P[U, V]$ is a theta-graph so that $P[U, V]$ has $3k$ or $4k$ edges. Then there exists a theta-graph with branching vertices being the endvertices of $P[U, V]$ that contains $P[U, V]$, an arc of C_1 , two of the paths P_A, P_B , and P_C , as well as two of the paths P_G, P_H , and P_I . Hence this theta-graph contains at least $3k + 2k + 2k$ edges in addition to the length of the included arc of C_1 . However, this length exceeds $7k$; a contradiction.

Hence no such chordal path exists. It follows that we may assume that $P[U, V]$ is a chordal path of the cycle $P_A \cup P_B \cup P_D \cup P_G$. This cycle together with $P[U, V]$ is a theta-graph so that $P[U, V]$ has a least $2k$ edges.

We may assume that U and V are not vertices of C_2 by the previous remarks and symmetry. Either U or V is a vertex of C_1 or not. In the former case then two of the paths P_A, P_B , and P_C together with a path Q formed from $P[U, V]$ and a segment of either P_A or P_B is a set of three internally disjoint paths from C_1 to C_2 . Hence each of these paths has k edges. However, Q has at least $2k$ edges; a contradiction. Hence

neither U nor V is a vertex of C_1 . Then $P[U, V]$ is a path between two internal vertices of P_A and P_B . Then $P_E \cup P_F$ together with $P[U, V]$ and segments of each of P_A and P_B forms a cycle that is vertex-disjoint from C_2 . Hence this cycle has $3k$ edges by the previous remarks. However, this cycle has at least $4k$ edges; a contradiction.

It follows from these observations that no such path $P[U, V]$ exists. Hence the edge set of G is S . It follows that G is a k -subdivision of the prism graph for some $k \in \mathbb{Z}^+$. This completes the proof of Theorem 4.8. \square

Note that Theorem 4.2 follows immediately from Lemma 4.7 and Theorem 4.8. \square

Bibliography

- [1] William G. Brown, *A new proof of a theorem of Dirac*, *Canad. Math. Bull.* **8** (1965), 459–463.
MR 0181583 (31 #5812)
- [2] Raul Cordovil, Bráulio Maia, Jr., and Manoel Lemos, *The 3-connected binary matroids with circumference 6 or 7*, *European J. Combin.* **30** (2009), no. 8, 1810–1824. MR MR2552663
- [3] Collette R. Coullard, John G. del Greco, and Donald K. Wagner, *Representations of bicircular matroids*, *Discrete Appl. Math.* **32** (1991), no. 3, 223–240. MR MR1120878 (92i:05072)
- [4] G. A. Dirac, *Some results concerning the structure of graphs*, *Canad. Math. Bull.* **6** (1963), 183–210. MR 0157370 (28 #604)
- [5] Joseph A. Gallian, *A survey: recent results, conjectures, and open problems in labeling graphs*, *J. Graph Theory* **13** (1989), no. 4, 491–504. MR 1010582 (90k:05132)
- [6] ———, *A dynamic survey of graph labeling*, *Electron. J. Combin.* **5** (1998), Dynamic Survey 6, 43 pp. (electronic). MR 1668059 (99m:05141)
- [7] S. R. Kingan, *Binary matroids without prisms, prism duals, and cubes*, *Discrete Math.* **152** (1996), no. 1-3, 211–224. MR 1388643 (97i:05020)
- [8] Manoel Lemos, Talmage Reid, and Haidong Wu, *On the circuit-spectrum of binary matroids*, *European Journal of Combinatorics*, to appear.
- [9] Bráulio Maia, Junior and Manoel Lemos, *Matroids having small circumference*, *Combin. Probab. Comput.* **10** (2001), no. 4, 349–360. MR MR1860441 (2002f:05047)
- [10] Laurence R. Matthews, *Bicircular matroids*, *Quart. J. Math. Oxford Ser. (2)* **28** (1977), no. 110, 213–227. MR MR0505702 (58 #21732)

- [11] U. S. R. Murty, *Equicardinal matroids and finite geometries*, Calgary International Conference, Gordon and Breach, New York, 1969.
- [12] ———, *Equicardinal matroids*, J. Combinatorial Theory Ser. B **11** (1971), 120–126.
MR MR0281638 (43 #7353)
- [13] Nancy Ann Neudauer, *Graph representations of a bicircular matroid*, Discrete Appl. Math. **118** (2002), no. 3, 249–262. MR MR1892972 (2003b:05047)
- [14] James G. Oxley, *Matroid theory*, Oxford Science Publications, The Clarendon Press Oxford University Press, New York, 1992. MR MR1207587 (94d:05033)
- [15] Donald K. Wagner, *Connectivity in bicircular matroids*, J. Combin. Theory Ser. B **39** (1985), no. 3, 308–324. MR MR815399 (87c:05041)
- [16] D. J. A. Welsh, *Matroid theory*, Academic Press [Harcourt Brace Jovanovich Publishers], London, 1976, L. M. S. Monographs, No. 8. MR MR0427112 (55 #148)
- [17] Douglas B. West, *Introduction to graph theory*, Prentice Hall Inc., Upper Saddle River, NJ, 1996. MR 1367739 (96i:05001)
- [18] Hassler Whitney, *On the abstract properties of linear dependence*, Amer. J. Math. **57** (1935), 509–533.
- [19] H. Peyton Young, *Existence theorems for matroid designs*, Trans. Amer. Math. Soc. **183** (1973), 1–35. MR MR0406834 (53 #10620)
- [20] Peyton Young and Jack Edmonds, *Matroid designs*, J. Res. Nat. Bur. Standards Sect. B **77B** (1973), 15–44. MR MR0382041 (52 #2929)
- [21] Peyton Young, U. S. R. Murty, and Jack Edmonds, *Equicardinal matroids and matroid-designs*, Proc. Second Chapel Hill Conf. on Combinatorial Mathematics and its Applications (Univ. North Carolina, Chapel Hill, N.C., 1970), Univ. North Carolina, Chapel Hill, N.C., 1970, pp. 498–542. MR MR0266782 (42 #1685)

VITA

The author, Torina Dechaune Lewis, was born in New Orleans, Louisiana on February 16, 1980. She is the daughter of the late Carolyn Lewis and Melvin Lewis. She attended John McDonogh Senior High School and graduated on May 15, 1998. On April 19, 1999 she enlisted in the Louisiana Army National Guard. After returning from training she was embraced by her unit the 1-244th Aviation in New Orleans, Louisiana. She still is an active member and proudly serves in the Mississippi Army National Guard. She graduated from Southern University at New Orleans December 2003. After completing her work at Southern, she enter Southern University Agricultural and Mechanical College earning a Master of Science in Mathematics. She completed all requirements for a Doctor of Philosophy in Mathematics at The University of Mississippi.